

LC16D

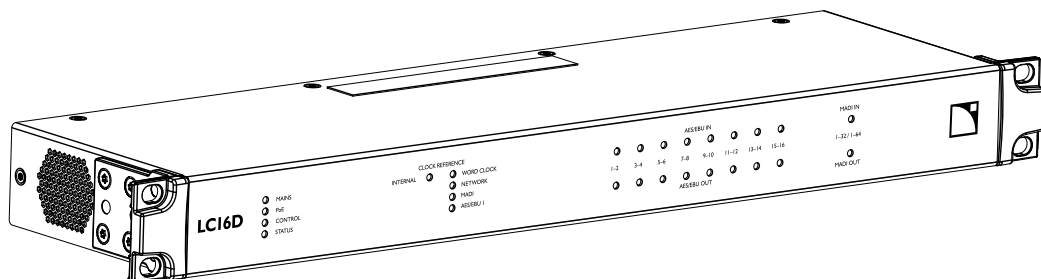

owner's manual (EN)



Document reference: LC16D owner's manual (EN) version 4.0

Distribution date: October 24, 2024

© 2024 L-Acoustics. All rights reserved.

No part of this publication may be reproduced or transmitted in any form or by any means without the express written consent of the publisher.













Contents





Safety.....	5
Important safety instructions.....	5
Introduction.....	7
LC16D Network audio converter.....	7
How to use this manual.....	8
Revision history.....	8
System components.....	9
System component illustrations.....	9
Technical description.....	11
Main features.....	11
Front and rear panels.....	11
Power supply.....	12
Signal processing.....	12
Signal inputs and outputs.....	12
Mapping.....	14
Monitoring and control.....	14
User interface.....	14
Remote control.....	15
Inspection and preventive maintenance.....	16
How to do preventive maintenance.....	16
CHK - External structure.....	16
CHK - Cleanness.....	16
CHK - Normal start-up sequence.....	17
CHK - Network functionalities and firmware.....	17
Installation.....	18
Mounting.....	18
Ventilation.....	18
General Purpose I/O (GPIO).....	19
Power over Ethernet.....	20
Connecting to AC mains.....	20
Electrical specifications.....	20
Power cord.....	21
Plugging LC16D.....	21
Power consumption.....	21
Audio and network cabling.....	21

Connectors.....	21
AES/EBU audio.....	22
MADI audio.....	23
Word clock.....	23
Milan-AVB or AES67.....	24
Cabling examples.....	25
Operation.....	26
Powering on/off.....	26
Interpreting the front panel LEDs.....	26
LC16D embedded Web interface.....	31
Top bar.....	31
Audio overview.....	32
AVB or AES67 input mapping.....	38
AVB output mapping.....	39
GPIO.....	41
Settings.....	43
Additional actions.....	46
Specifications.....	47

Safety

Important safety instructions

- 
Inspect the product before operation.
 If any sign of defect or damage is detected, immediately withdraw the product from use for maintenance.
- 
Perform preventive maintenance at least once a year.
 Refer to the preventive maintenance section for a list of actions and their periodicity.
 Insufficient upkeep of the product can void the warranty.
- 
Verify the electrical conformity and compatibility of the mains supply.
 Only connect the product to an AC power outlet rated 100-240 V, 50-60 Hz.
 The product draws 8 W (typical).
WARNING: The product is of Class I construction and shall be connected to a mains socket outlet with a Protective Earth connection.
- 
When the product is used in a three-phase circuit, verify the electrical conformity and compatibility of the three-phase circuit.
 Verify that the three phases work, and balance the loads between the three phases.
 Verify that the neutral and earth work.
 Never try to emulate a 230 V circuit connecting an apparatus to two live wires of a 120 V three-phase circuit.
 Never try to emulate a 200 V circuit connecting an apparatus to two live wires of a 100 V three-phase circuit.
- 
Electrical generator
 You must power on the generator before powering on the product.
 Verify that the product is turned off before powering on the generator.
- 
Never incorporate equipment or accessories not approved by L-Acoustics.
Read all the related PRODUCT INFORMATION documents shipped with the products before exploiting the system.
- 
Intended use
 This system is intended for use by trained personnel for professional applications.
- 
As part of a continuous evolution of techniques and standards, L-Acoustics reserves the right to change the specifications of its products and the content of its documents without prior notice.
 Check www.l-acoustics.com on a regular basis to download the latest document and software updates.
- 
Do not use the product outside its operating temperature range.
 The product operates at a room temperature between -5 °C / 23 °F and 50 °C / 122 °F.
 Do not expose the product to direct sun.
- 
Do not expose the product to extreme conditions.
 Do not expose the product to moisture (rain, mist, sea spray, steam, humidity, condensation...) or excessive heat (direct sun, radiator...) for a long period of time.
 For more information, refer to the **Products weather protection** document, available on the website.
- 
Use the product in a conformed electro-magnetic environment.
 The product can be used in the following environment: residential (class B).
Avoid radio interference.
 This product has been tested and complies with the regulations of the EMC directive (Electro Magnetic Compatibility). These regulations are designed to provide reasonable protection against harmful interference from electrical equipment, but it cannot be guaranteed that interference will never occur.
- 
Product disconnection
 To completely disconnect this product from the mains, disconnect the power supply cord plug from the mains socket outlet.

-  **Power supply cord and socket accessibility**
The main plug of the power supply cord shall remain easily accessible.
The mains socket outlet shall be easily accessible.
-  **Read the maintenance section of this document before servicing the product.**
-  **Contact L-Acoustics for advanced maintenance.**
Any unauthorized maintenance operation will void the product warranty.
-  **Shipping**
Use the original packaging for shipping the product, unless it is mounted in a rack with the front fixed to the rack, as described in this manual.

Symbols on the product



Explanation of graphical symbols



The lightning flash with arrowhead symbol within an equilateral triangle is intended to alert the user to the presence of uninsulated "dangerous voltage" within the product's enclosure that may be of sufficient magnitude to constitute a risk of electric shock to persons.



The exclamation point within an equilateral triangle is intended to alert the user to the presence of important operating and maintenance instructions in the literature accompanying the product.



Do not open unless authorized. This symbol indicates the presence of electrical shock hazards. It also indicates that no maintenance performed by the end user requires access to internal components.



This marking indicates that this product should not be disposed of with other household waste throughout the EU. To prevent possible harm to the environment or human health from uncontrolled waste disposal, recycle it responsibly to promote the sustainable reuse of material resources. To return your used device, please use the return and collection systems or contact the retailer where the product was purchased. They can take this product for environmentally safe recycling.

Introduction

LC16D Network audio converter



LC16D is a multichannel converter that bridges MADI and AES/EBU legacy digital formats bidirectionally with a Milan-AVB network. Supporting up to 128 Milan-AVB inputs and outputs simultaneously, LC16D offers dynamic mapping of channels, and comprehensive synchronization options, with remote control via a simple to use embedded Web interface. Flexible power options and seamless Milan-AVB network audio connections deliver robust redundancy features as standard, all housed in a compact and rugged 1RU chassis.

Legacy audio protocols, such as MADI and AES/EBU, continue to be used extensively across the professional audio industry. LC16D enables interfacing and conversion between these formats and a deterministic, redundant Milan-AVB network. Up to 16 AES/EBU inputs and outputs can be connected, with asynchronous sample rate converters (ASRC) available on each input pair, enabling sources from multiple clock domains to be accommodated. The ASRCs can also be disabled as required. MADI offers a high-density connection which is widely supported by most digital mixing platforms and playback devices. At 96 kHz sampling rate, 32 input and 32 output channels are available, and at 48 kHz, 64 inputs and outputs are supported.

LC16D features an alternative network mode, allowing it to receive up to 16 streams of AES67 network audio, of up to eight channels each at 48 kHz, and convert them to AES/EBU and MADI format outputs. Similar to Milan-AVB, the AES67 input mode also provides seamless redundancy for further peace of mind. This expanded functionality significantly enhances LC16D's usability across a wide range of applications.

LC16D is designed as a plug-and-play device: out of the box all legacy digital inputs and outputs are presented to the Milan-AVB streams with a one-to-one channel mapping, AES/EBU first and then MADI. Only the required clock reference needs to be selected and LC16D is ready to pass audio. While providing this straightforward conversion the freedom to dynamically map channels is also available. Collectively, up to 80 legacy digital input sources and 80 output destinations can be connected to and from the Milan-AVB network. The remaining Milan-AVB channels, from the available 128 outputs, can be utilized to combine selections of AES/EBU and MADI input channels, creating custom Milan-AVB streams for optimized distribution to multiple network destinations. The dynamic mapping function also allows diverse network audio sources across multiple streams to be routed to the MADI and AES/EBU outputs from the network, bringing additional flexibility and versatility.

With LC16D no additional remote-control software is needed, the comprehensive embedded Web interface is simple and intuitive to use. Any device with a web browser and IP connection can be used to control, configure, and manage the LC16D, including basic settings, channel mapping, and setup of the GPIOs. Additionally, ten onboard user memories are available to store and load configurations. These can also be saved to a remote device, to build a library of configurations for backup or transferring between multiple LC16D.

How to use this manual

The LC16D owner's manual is intended for all actors involved in the system design, implementation, preventive and corrective maintenance of the LC16D product. It must be used as follows:

1. Read the technical description for an overview of all product elements, their features, and their compatibilities.
 - [Technical description](#) (p.11)
2. Before installing the product, perform mandatory inspections and functional checks.
 - [Inspection and preventive maintenance](#) (p.16)
3. To deploy the product, follow the step-by-step installation instructions and refer to the cabling schemes.
 - [Installation](#) (p.18)
 - [Audio and network cabling](#) (p.21)
4. To configure the settings and parameters of the product, follow the step-by-step operation instructions.
 - [Operation](#) (p.26)

As part of a continuous evolution of techniques and standards, L-Acoustics reserves the right to change the specifications of its products and the content of its documents without prior notice.

Check www.l-acoustics.com on a regular basis to download the latest document and software updates.





Contact information

For information on advanced corrective maintenance:

- contact your Certified Provider or your L-Acoustics representative
- for Certified Providers, contact the L-Acoustics customer service: customer.service@l-acoustics.com (EMEA/APAC), laus.service@l-acoustics.com (Americas).

Symbols

The following symbols are used in this document:

-  This symbol indicates a potential risk of harm to an individual or damage to the product. It can also notify the user about instructions that must be strictly followed to ensure safe installation or operation of the product.
-  This symbol indicates a potential risk of electrical injury. It can also notify the user about instructions that must be strictly followed to ensure safe installation or operation of the product.
-  This symbol notifies the user about instructions that must be strictly followed to ensure proper installation or operation of the product.
-  This symbol notifies the user about complementary information or optional instructions.

Revision history

version number	publication date	modification
1.0	Nov. 2023	Initial version.
2.0	Feb. 2024	Updated section LC16D embedded Web interface (p.31).
3.0	Apr. 2024	Added section Inspection and preventive maintenance (p.16).
4.0	Oct. 2024	<ul style="list-style-type: none"> • Updated section LC16D embedded Web interface (p.31) with AES67 mode. • Added AES67 specifications.

This version of the Owner's Manual describes the LC16D firmware version 2.13.1.



As part of a continuous evolution of techniques and standards, L-Acoustics reserves the right to change the specifications of its products and the content of its documents without prior notice.

Check www.l-acoustics.com on a regular basis to download the latest document and software updates.

System components

Network audio converters

LC16D Network audio converter

Cables

DBM2 LC16D input cable (1 DB25 male to 8 XLR male, AES59 8-way pinout, AES/EBU grade)
Length: 2 m / 6.6 ft

DBF2 LC16D output cable (1 DB25 male to 8 XLR female, AES59 8-way pinout, AES/EBU grade)
Length: 2 m / 6.6 ft

Software applications

LC16D embedded
Web interface User interface

Accessed by typing the device IP address into a Web browser.

L-Acoustics Device
Scanner Discovery and IP configuration utility for L-Acoustics devices (except L-ISA processors) on an
Ethernet network

USB Terminal Basic configuration utility used through a USB connection

Milan Manager Milan-compatible ATDECC (AVDECC) Controller
Used to connect and monitor Milan-AVB streams across a network.

Hive AVB Controller Milan-compatible ATDECC (AVDECC) Controller
Used to connect and monitor Milan-AVB streams across a network.



Refer to the L-Acoustics Device Scanner user guide.

System component illustrations

Cables

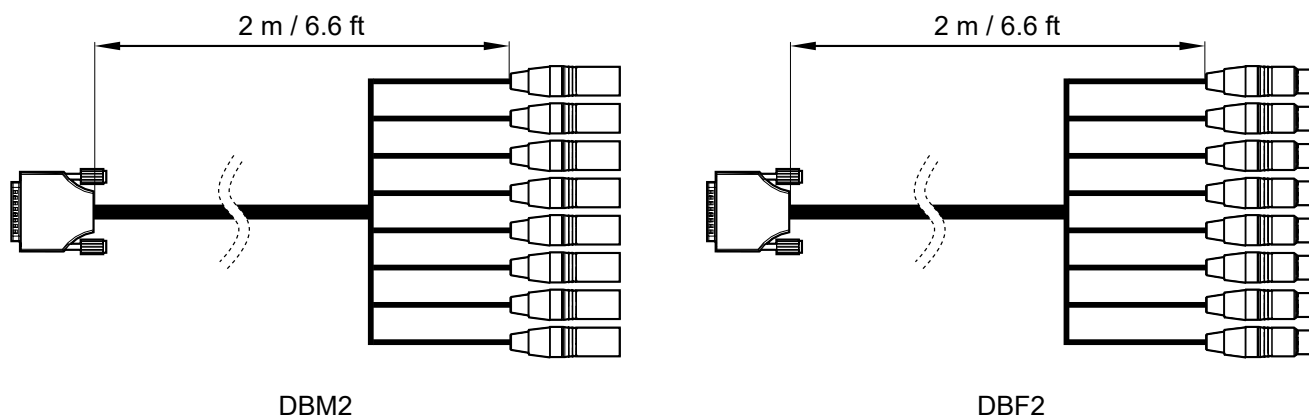

Software applications

WebUI

LC16D
embedded
Web interface



L-Acoustics
Device Scanner



USB Terminal



Milan Manager

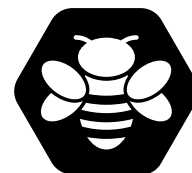

Hive AVB Controller

Technical description

Main features

Front and rear panels



1. LEDs for the general status of the unit:
 - single color LED for mains presence
 - single color LED for PoE (Power over Ethernet) presence
 - dual color LED for status of the remote control
 - dual color LED for the general status of the unit
2. LEDs for clock references:
 - single color LED for internal clock
 - single color LED for word clock
 - single color LED for network (Milan-AVB clock or PTP clock)
 - single color LED for MADI clock
 - single color LED for AES/EBU 1 clock
3. LEDs for status/signal/clip of the AES/EBU signals:
 - 8 dual color LEDs for the AES/EBU inputs (one per pair)
 - 8 dual color LEDs for the AES/EBU outputs (one per pair)
4. LEDs for status/signal/clip of the MADI signals:
 - dual color LED for the MADI inputs
 - dual color LED for the MADI outputs

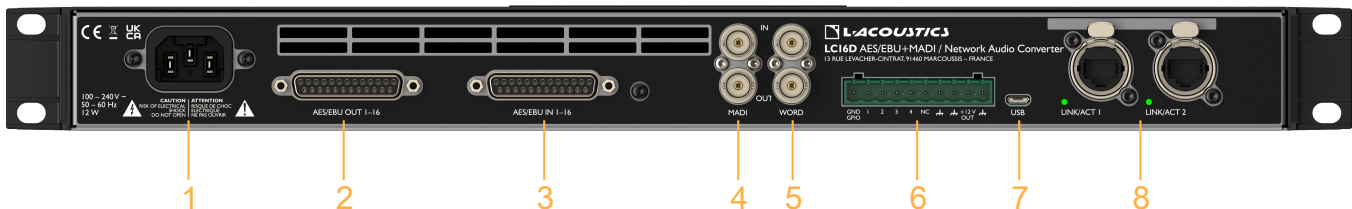

1. IEC C13 V-Lock compatible socket
2. DB25 female connector (AES59 8-way pinout annex C) for 16 AES/EBU outputs, with UNC 4-40 screw locks
3. DB25 female connector (AES59 8-way pinout annex C) for 16 AES/EBU inputs, with UNC 4-40 screw locks
4. BNC connector for MADI inputs and BNC connector for MADI outputs (75 Ω terminated)
5. BNC connector for Word clock input and BNC connector for Word clock output (75 Ω terminated)
6. 10-point terminal block General Purpose I/O (GPIO)
7. Micro USB service port
8. 2 x 1 Gb/s Ethernet etherCON I/Os for Milan-AVB I/O, AES67 inputs, network I/O, and PoE (Power over Ethernet) inputs

Power supply

LC16D power supply offers three redundant possibilities.

LC16D is equipped with a universal Switched Mode Power Supply (SMPS) suitable for mains from 100 V AC - 240 V AC ($\pm 10\%$), 50 Hz - 60 Hz.

LC16D is a Class 3 Powered Device (PD) featuring seamless power redundancy between the mains input and PoE (Power over Ethernet). In case of failure of the mains power supply, a third-party Power Sourcing Equipment (PSE) can power LC16D through either of the 1 Gb/s Ethernet ports (PoE1 and PoE2). LC16D is compatible with any IEEE 802.3at-2009 PSE.

Refer to section [Installation](#) (p.18) for detailed operating instructions.

Signal processing

Signal inputs and outputs

Milan-AVB

LC16D can operate in normal network mode or in redundant network mode. In both modes, 16 Milan-AVB input streams of up to 8 channels each can be connected to LC16D.

Input channels can be freely assigned to the 16 Milan-AVB output streams through a flexible matrix in the LC16D embedded Web interface.

Each Ethernet port uses a high speed data transfer protocol up to 1 Gb/s and supports the AAF PCM32 stream format with stream frequencies at 48 kHz when the device is operating at 48 kHz or 96 kHz when the device is operating at 96 kHz.

AES67

LC16D can operate in normal network mode or in redundant network mode.

In both modes, 16 AES67 streams of up to eight channels may be connected to LC16D.

Each Ethernet port uses a high speed data transfer protocol up to 1 Gb/s and supports the L16 and L24 stream formats with stream frequencies of 48 kHz.

LC16D synchronizes its media clock to the PTPv2 network clock. The BMCA (Best Master Clock Algorithm) automatically elects the PTPv2 network clock from the device with the lowest PTPv2 priorities. Use the LC16D embedded Web interface to adjust the priority values. It is recommended to set high values so that LC16D is clock follower.

In normal network mode, the Ethernet ports operate as part of a bridge and may therefore be used to create a daisy-chain network. In this case, LC16D operates as a boundary PTP clock.

In redundant network mode, each port is dedicated to separate networks: first port for primary network, second port for secondary network. In this case, LC16D operates as an ordinary clock.

Input channels can be freely assigned to the AES/EBU or MADI output channels through flexible summing matrix using the LC16D embedded Web interface.

AES/EBU (AES3)

LC16D can be fed with up to 16 AES/EBU (AES3) digital audio signals (transported in pairs) using the **AES/EBU INPUTS 1-16** DB25 female connector. There is no latency compensation and no bypass/link. The input signals can be transmitted to the Milan-AVB output streams.

Each input signal has integrated ASRC (Asynchronous Sample Rate Converter) supporting a wide range of input formats (44.1 kHz to 192 kHz). The ASRC converts the signals to the rate selected for LC16D (48 kHz or 96 kHz). The ASRC can be disabled individually for each AES/EBU input.

LC16D can send up to 16 AES/EBU (AES3) digital audio signals (transported in pairs) coming from the Milan-AVB or AES67 input streams using the **AES/EBU OUTPUTS 1-16** DB25 female connector. There is no latency compensation.

MADI (AES10-2003)

LC16D can be fed with up to 64 AES10 digital audio signals (at 48 kHz) or 32 AES10 digital audio signals (at 96 kHz) using the **MADI IN** BNC connector. The input signals can be transmitted to the Milan-AVB output streams.

LC16D can send up to 64 AES10 digital audio signals (at 48 kHz) or 32 AES10 digital audio signals (at 96 kHz) coming from the Milan-AVB or AES67 input streams using the **MADI OUT** BNC connector.

i The 96 kHz legacy SMUX pattern is not supported.

Clocking

In Milan-AVB mode, LC16D synchronizes its media clock according to the selection done by the user.

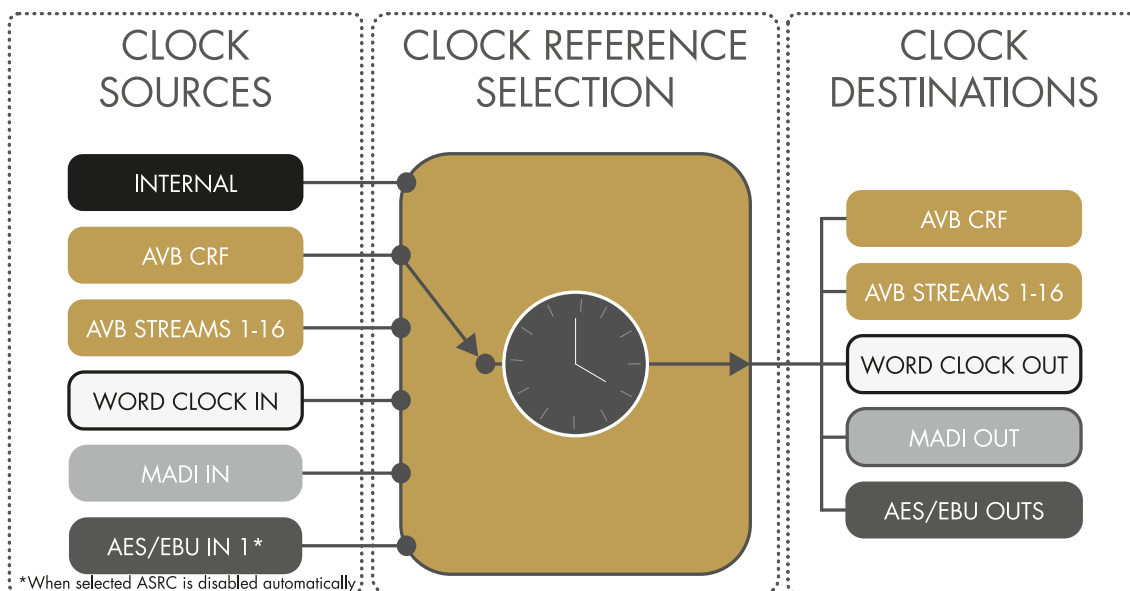

In AES67 mode, LC16D synchronizes its media clock to the BMCA-elected PTP leader or to its internal clock if LC16D is the elected PTP leader.

Mapping

LC16D has a default mapping of the inputs and outputs that can be modified using the LC16D embedded Web interface. The same Milan-AVB or AES67 input streams can be used several times in the mapping.

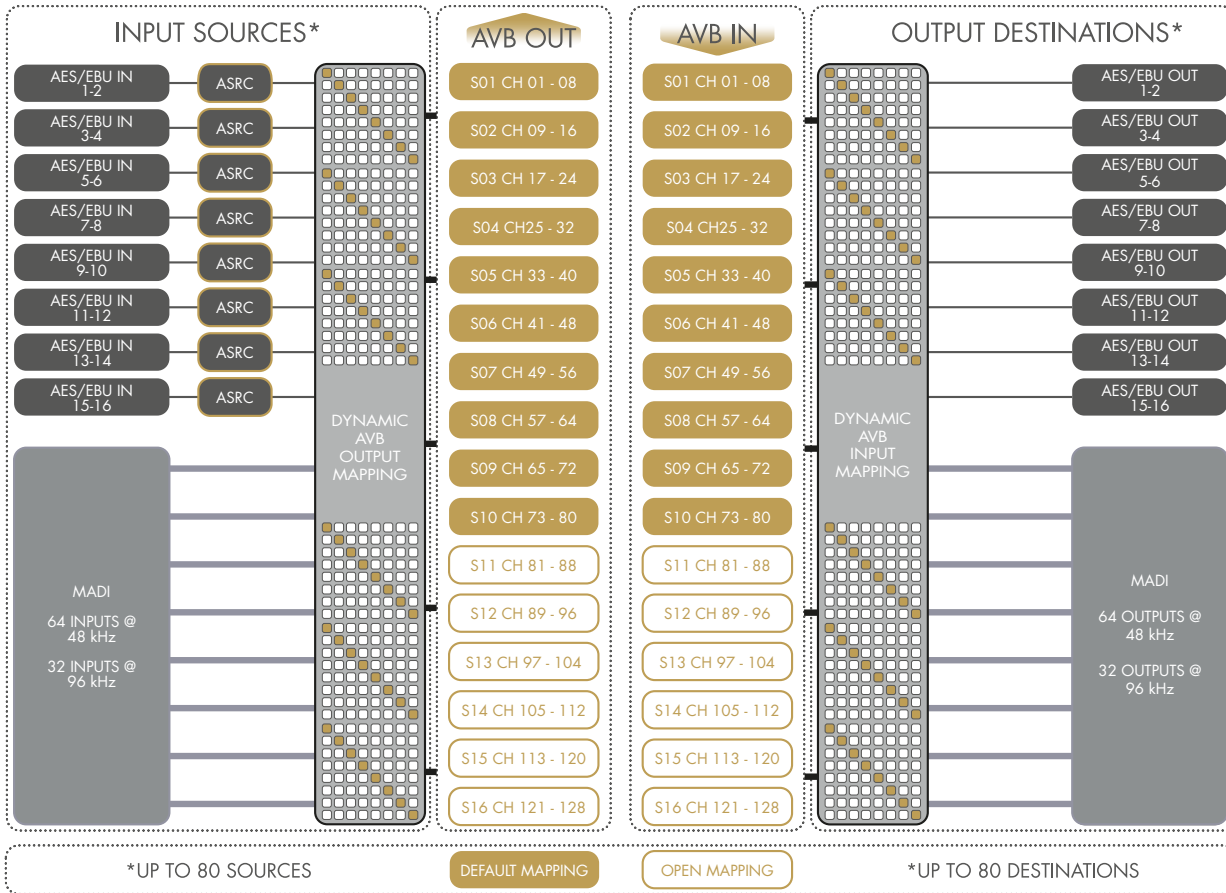

i In AES67 mode, LC16D acts only as receiver. Conversion of input sources to AES67 is disabled.

Mapping is possible from the Milan-AVB or AES67 inputs to the AES/EBU and MADI outputs, and from the AES/EBU and MADI inputs to the Milan-AVB outputs. Direct mapping between Milan-AVB inputs and outputs is not possible, neither is it possible to map between AES/EBU and MADI.

LC16D does not feature any DSP and as such, cannot be used to apply EQ, gain, delay, or mute functionalities.

Use an AVDECC Controller (such as **Milan Manager** or **Hive**) to connect the Milan-AVB input streams to LC16D.

Monitoring and control

User interface

The LED display on the front panel provides real-time monitoring functionalities:

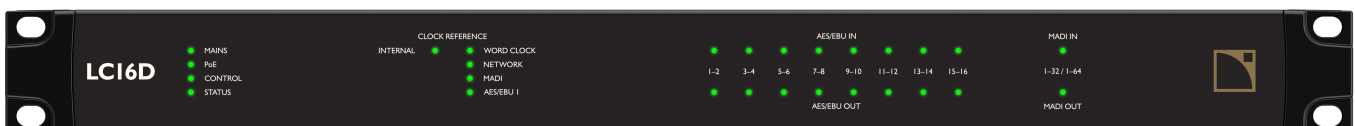

- General status of the unit:
 - mains presence
 - PoE (Power over Ethernet) presence
 - status of the remote control
 - general status of the unit
- Clock references:

- internal clock
- word clock
- network (Milan-AVB clock or PTP clock)
- MADI clock
- AES/EBU 1 clock
- Status/signal/clip of the inputs:
 - AES/EBU inputs (one per pair)
 - MADI inputs
- Status/signal/clip of the outputs:
 - AES/EBU outputs (one per pair)
 - MADI outputs

Refer to section [Operation](#) (p.26) for detailed operating instructions.

Remote control

With its factory default settings, LC16D can be used out of the box to convert MADI and AES/EBU formats to Milan-AVB streams ready to be connected to AVB-capable devices.

When switched to AES67 network audio mode, LC16D can be used to convert AES67 input streams to MADI and AES/EBU outputs for non AES67-capable devices.

The IP settings, Milan-AVB or AES67 mapping, and the GPIO configuration can be edited from the **LC16D embedded Web interface**. Use an AVDECC Controller (such as **Milan Manager** or **Hive**) to connect the Milan-AVB input streams to LC16D.

Once LC16D is configured, there is no need to continue remote control: it will continue to function. After a reboot or being turned off and on again, LC16D continues to apply the last used configuration.

Refer to section [Operation](#) (p.26) for detailed operating instructions.

LC16D embedded Web interface

LC16D incorporates an embedded Web interface for remote control and monitoring which can be accessed by any device with a Web browser and network connection.

To connect LC16D and the control computer, use either industry standard CAT5e U/FTP cables (or cables of higher categories) fitted with RJ45 connectors, or a micro USB cable.

The 10-point terminal block General Purpose I/O (GPIO) can be configured to store and recall up to 10 user configurations. Refer to [General Purpose I/O \(GPIO\)](#) (p.19).

USB Terminal

USB Terminal is an interface available on the L-Acoustics website. To connect LC16D and the control computer, use a micro USB cable.

Use USB Terminal to connect to devices and change their IP settings or reset them to factory settings.

L-Acoustics Device Scanner

L-Acoustics Device Scanner is an application available on the L-Acoustics website. To connect LC16D and the control computer, use industry standard CAT5e U/FTP cables (or cables of higher categories) fitted with RJ45 connectors.

Use L-Acoustics Device Scanner to connect to devices even if their IP addresses are unknown, and:

- Solve IP address conflict between devices.
- Update the firmware.
- Identify, reboot, configure a password.
- Retrieve the logs, find the MAC Address and Serial Number.

Refer to the **L-Acoustics Device Scanner Technical Bulletin** for more information.

Inspection and preventive maintenance

How to do preventive maintenance

Inspect the product periodically as indicated, and after any corrective maintenance operation.

Structure and cleanness

Before and after each deployment (touring applications), or at least once a month (fixed installations):

- [CHK - External structure](#) (p.16)
- [CHK - Cleanness](#) (p.16)

Functionalities

At least once a year:

- [CHK - Normal start-up sequence](#) (p.17)
- [CHK - Network functionalities and firmware](#) (p.17)

CHK - External structure

The  indicates a visual inspection.

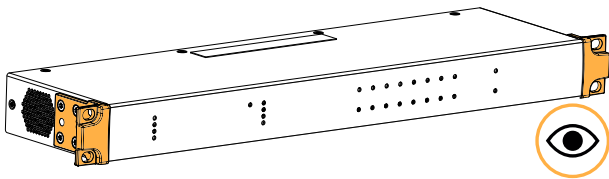

side brackets are present and not damaged

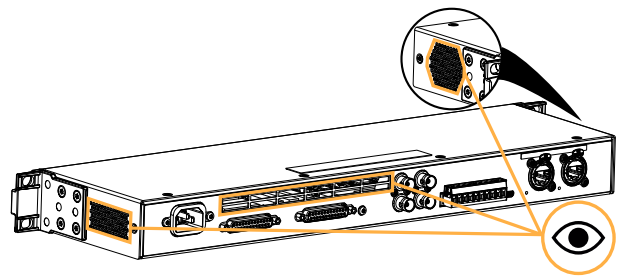

rear and side grills and clean are not damaged
see also [CHK - Cleanness](#) (p.16)

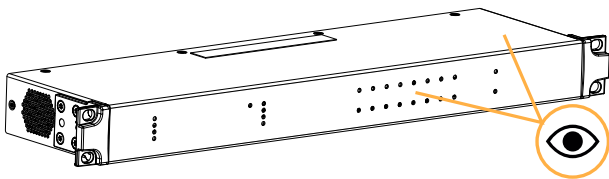

chassis and LEDs are not damaged

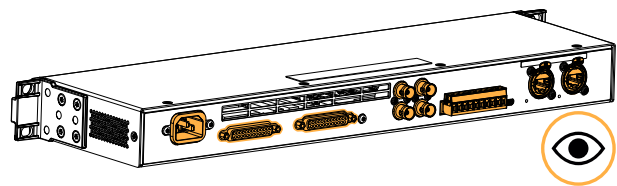

connectors are not damaged

CHK - Cleanness

Equipment

- air blower

Procedure

Clean the product through the side grills with an air blower.

CHK - Normal start-up sequence

Procedure

1. Plug the product to the mains.
2. Check that all LEDs light up briefly in green or orange.

CHK - Network functionalities and firmware

Equipment

- computer with L-Acoustics Device Scanner
- appropriate network cable

Procedure

1. If the IP address of the product is unknown:
 - a) Connect the micro USB port of the product to the computer using a USB cable.
 - b) Open the USB Terminal utility.
Refer to the USB Terminal documentation for more information.
 - c) Assign a new IP address if necessary, or reset the product to its default factory settings.
The default IP is 192.168.1.100.
2. Connect the Ethernet port 1 of the product to the computer using a network cable.
3. Run L-Acoustics Device Scanner, and check that the product is detected.
Refer to the **L-Acoustics Device Scanner** user guide for more information.
4. If convenient, update the firmware to the latest version.
Download the latest version of the firmware from the product page on www.l-acoustics.com.

Installation

Mounting

LC16D is one rack units high (1U) and can be mounted in an EIA-standard 19" rack using the four points on the front panel. Use the fixing material provided by the rack manufacturer to mount the device to the rack front rails.

LC16D dimensions

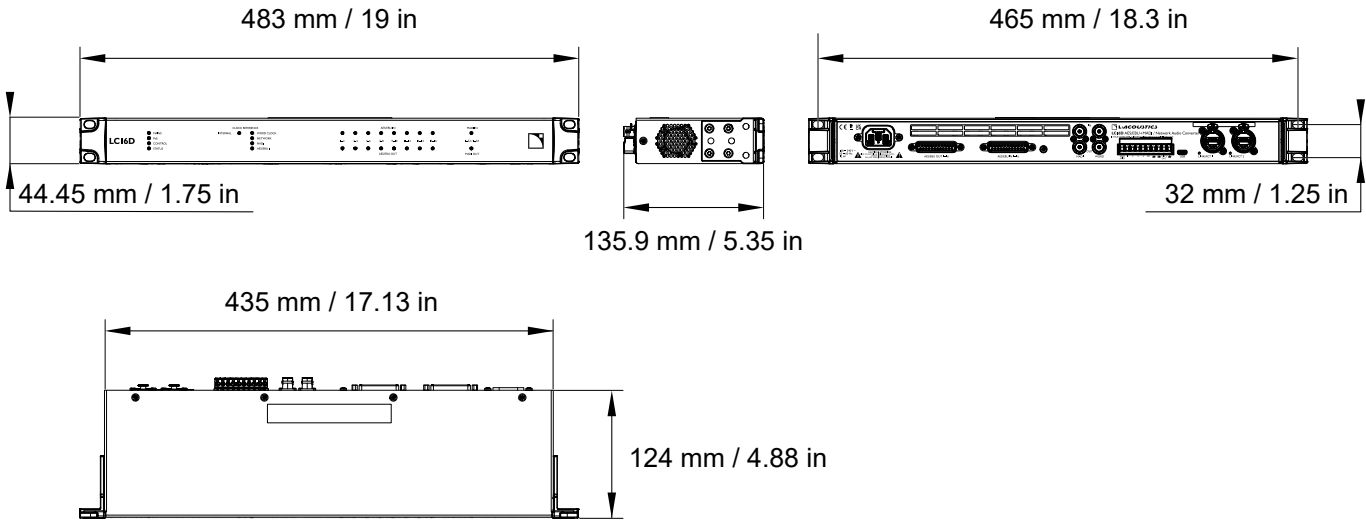

LC16D is not compatible with L-CASE II.

Ventilation

LC16D is equipped with a fan and one grill on each side to ventilate the device.



Do not block the side ventilation grills.

Install LC16D with the side panels at a minimum distance of 5 cm / 1.9 in from any external object or structure. When rack-mounted, the same distance must be guaranteed on both sides of the rack: make sure airflow is not reduced.

General Purpose I/O (GPIO)

LC16D features a 10-point terminal block General Purpose I/O (GPIO) connector.

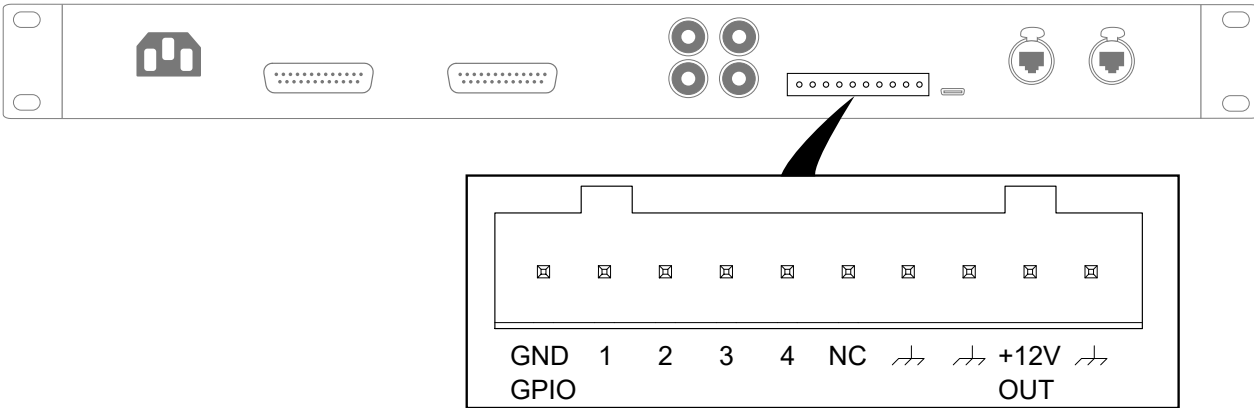

GND GPIO	ground
1	input or output
2	
3	
4	
NC	not connected
⌞	chassis ground
⌞	chassis ground
+12V OUT	for powering a contact relay (45 mA maximum)
⌞	chassis ground

GPIO can be configured using the LC16D embedded Web interface. For more information, refer to [Operation](#) (p.26).

Power over Ethernet

LC16D is a Class 3 Powered Device (PD) featuring seamless power redundancy between the mains input and PoE (Power over Ethernet). In case of failure of the mains power supply, a third-party Power Sourcing Equipment (PSE) can power LC16D through either of the 1 Gb/s Ethernet ports (PoE1 and PoE2). LC16D is compatible with any IEEE 802.3at-2009 PSE.

When LC16D is connected to three power supplies (mains and two PSEs), it is powered by the mains power supply in priority. In case of failure of the mains power supply, LC16D is powered through the first PoE1 (second priority after the mains). In case of a failure of the PSE connected to PoE1 during a failure of the mains power supply, LC16D is powered through PoE2 (third priority). LC16D automatically switches back to PoE1 or the mains as available.

The PSE can be a PoE injector, or a PoE switch. PoE switches should be AVB-capable switches if LC16D is used in an Milan-AVB network.

Use CAT6A U/FTP patch cables (straight-through), AWG24, 100 m / 328 ft max.

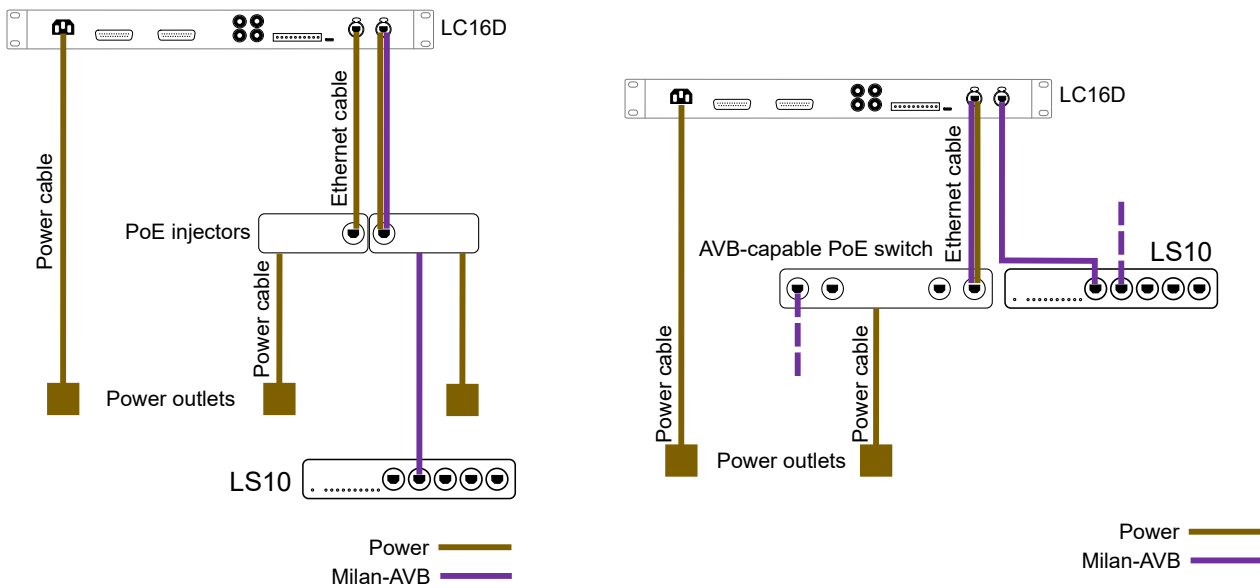

With two PoE injectors and LS10

With an AVB-capable PoE switch and LS10

L-Acoustics LS10 is an AVB-capable switch but is not a PSE device. Refer to the **LS10 Owner's Manual**.

Connecting to AC mains

Electrical specifications

AC mains specifications



Verify the electrical conformity and compatibility of the mains supply.

Only connect the product to an AC power outlet rated 100-240 V, 50-60 Hz.

The product draws 8 W (typical).

WARNING: The product is of Class I construction and shall be connected to a mains socket outlet with a Protective Earth connection.

Three-phase circuit



When the product is used in a three-phase circuit, verify the electrical conformity and compatibility of the three-phase circuit.

Verify that the three phases work, and balance the loads between the three phases.

Verify that the neutral and earth work.

Never try to emulate a 230 V circuit connecting an apparatus to two live wires of a 120 V three-phase circuit.

Never try to emulate a 200 V circuit connecting an apparatus to two live wires of a 100 V three-phase circuit.

Power cord

The removable power cord is fitted with a V-Lock compatible IEC connector at one end, and a country-specific plug at the other end.

type	plug	cable ratings	live	neutral	ground
CE	CEE7/VII, earthed	10 A / 250 V	brown	blue	green/yellow
CN	GB 2099, earthed				
INT	bare ends (local powerplug to be fitted)				
US	NEMA 5-15, earthed	10 A / 125 V	black	white	green



Strictly apply the specific safety regulations of the country of use.

Do not defeat the ground connection of the supplied power cord using an adaptor or any other method.

A suitable plug must be wired to the INT power cord.

If the power plug does not match the local power outlet, have a qualified electrician wire a suitable plug.

Plugging LC16D

How to plug LC16D to the AC mains.

Procedure

- First, connect the IEC connector to the LC16D IEC C13 socket.



Make sure the cable is properly locked.



- Then, connect the power plug to the mains socket.
LC16D features a power LED. LC16D is operational in less than 8 seconds.
- To power off LC16D, unplug the power cord from the mains socket.

Power consumption

LC16D power requirement is 12 W maximum.

Audio and network cabling

Connectors

The rear panel of LC16D features connectors for audio and network cabling:

1. For the connection of the digital AES/EBU audio sources inputs and outputs.
2. For the connection of the MAD1 AES10-2003 audio sources inputs and outputs, and input and output clocks.
3. For the connection of the Milan-AVB or AES67 network, and to be remotely controlled through the LC16D embedded Web interface.

LC16D audio and network connection panels

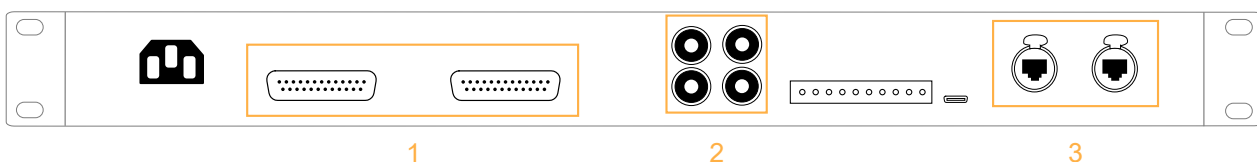

AES/EBU audio

Use the two DB25 female connectors for AES/EBU signal cabling.

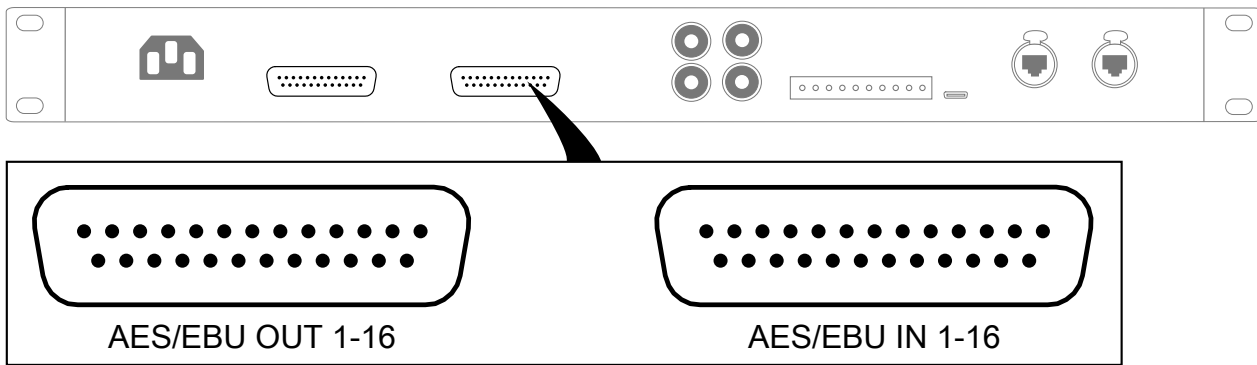

The connectors are wired according to the AES59 8-way pinout annex C standard.

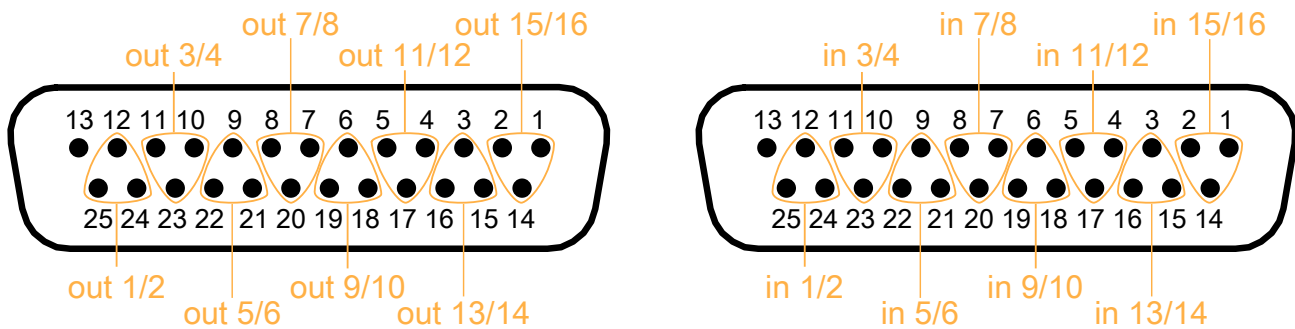

DB25 female connectors			
channels in/out	+	-	shield
1/2	24	12	25
3/4	10	23	11
5/6	21	9	22
7/8	7	20	8
9/10	18	6	19
11/12	4	17	5
13/14	15	3	16
15/16	1	14	2
not used	13		

AES/EBU IN 1-16 can receive up to 16 AES/EBU digital audio signals (transported in pairs). The default mapping is to Milan-AVB output streams 1 and 2.

AES/EBU OUT 1-16 can transmit up to 16 AES/EBU digital audio signals (transported in pairs). The default mapping is from input streams 1 and 2.

The two DB25 female connectors are fitted with UNC 4-40 screw locks.

MADI audio

Use the two **MADI** BNC connectors for AES10-2003 signal cabling.

Both connectors are 75 Ω terminated.

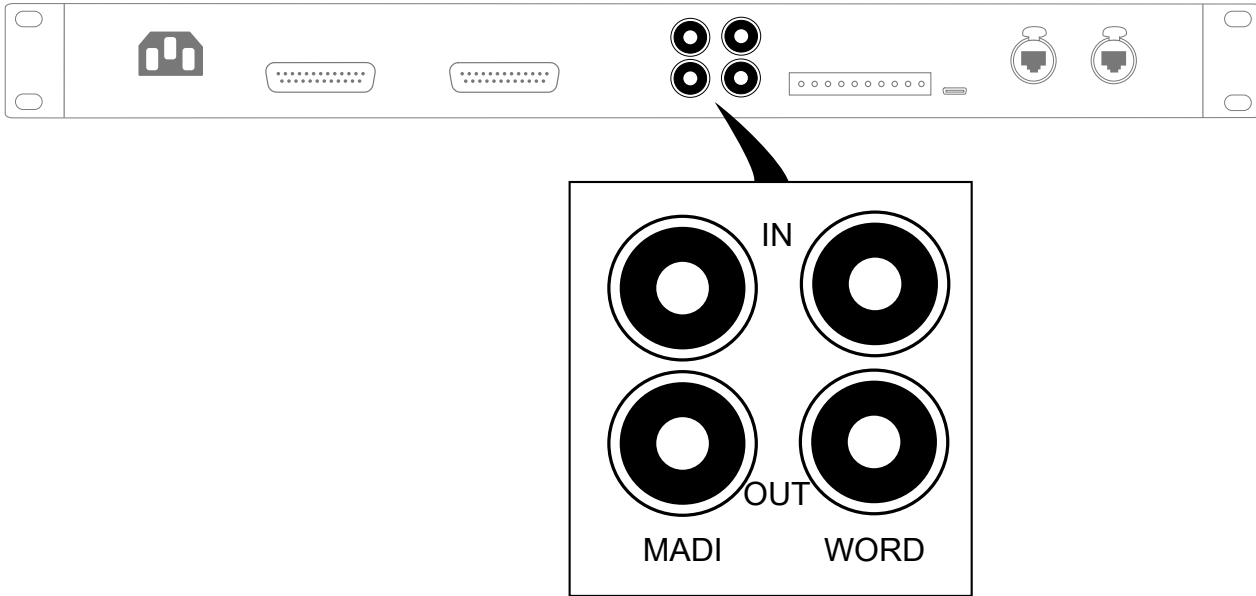

MADI IN can receive up to 64 AES10 digital audio signals at 48 kHz or 32 AES10 digital audio signals at 96 kHz. There is no sample rate conversion. The default mapping is to output streams 3 to 10 (at 48 kHz) or to output streams 3 to 6 (at 96 kHz).

MADI OUT can transmit up to 64 AES10 digital audio signals at 48 kHz or 32 AES10 digital audio signals at 96 kHz. There is no sample rate conversion. The default mapping is from input streams 3 to 10 (at 48 kHz) or from input streams 3 to 6 (at 96 kHz).



The 96 kHz legacy SMUX pattern is not supported.

Word clock

Use the two **WORD** BNC connectors for word clock cabling.

Both connectors are 75 Ω terminated.

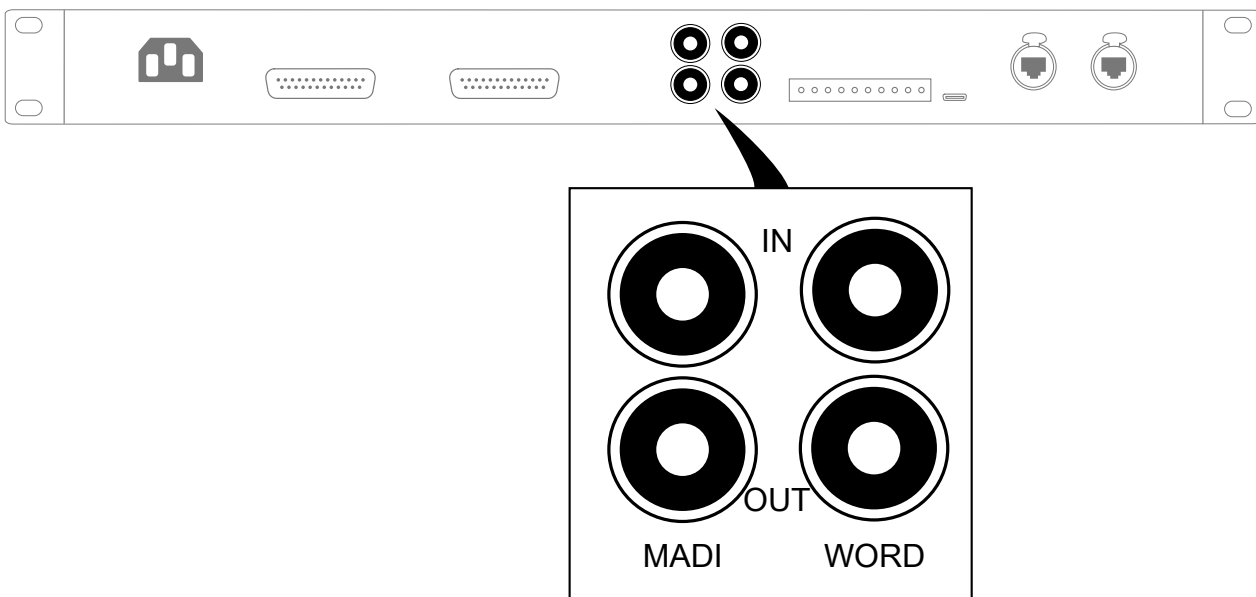

The supported input frequency is 48 kHz or 96 kHz. **WORD IN** accepts input levels from 1 V_{pp} to 5 V_{pp}, and is protected from overvoltage. **WORD OUT** output level is 5 V_{pp} into open load.

Milan-AVB or AES67

Use the two etherCON connectors for the remote control of LC16D using the LC16D embedded Web interface and an AVDECC Controller (such as **Milan Manager** or **Hive**). In Milan-AVB mode, the Ethernet ports are AVB-capable. Real-time audio traffic and control traffic are automatically managed by Milan-AVB on the same network.

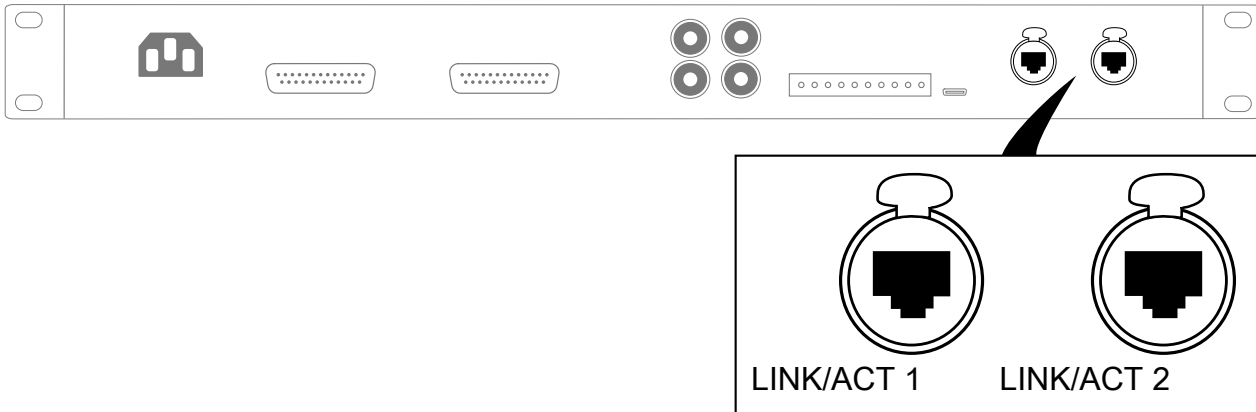

In normal network mode and Milan-AVB mode, the two etherCON connectors are part of an internal Milan-AVB switch. In AES67 mode, the internal switch operates as boundary clock.

In redundancy mode, the two etherCON connectors are independent. The LINK/ACT 1 connector is used for the primary network, and the LINK/ACT 2 connector is used for the secondary network.

LC16D can receive and send up to 16 streams in normal and in redundant mode, with up to 8 channels per stream, at 48 kHz or 96 kHz (depending on the unit setting).



Do not create loops in the network setup.



In daisy-chain networks, always place LA4X with hardware version* ID1, ID2 or ID3, LA4, and LA8 after any other type of amplified controller.

These amplified controllers are equipped with former generation 100 Mb/s Ethernet ports that cannot communicate with Ethernet ports of different capabilities, creating detection issues in LA Network Manager.

*The LA4X hardware version is visible in the MONITORING & INFO menu (HARDWARE INFO section).

Cabling examples

Festivals - LC16D as an AES/EBU to Milan-AVB converter

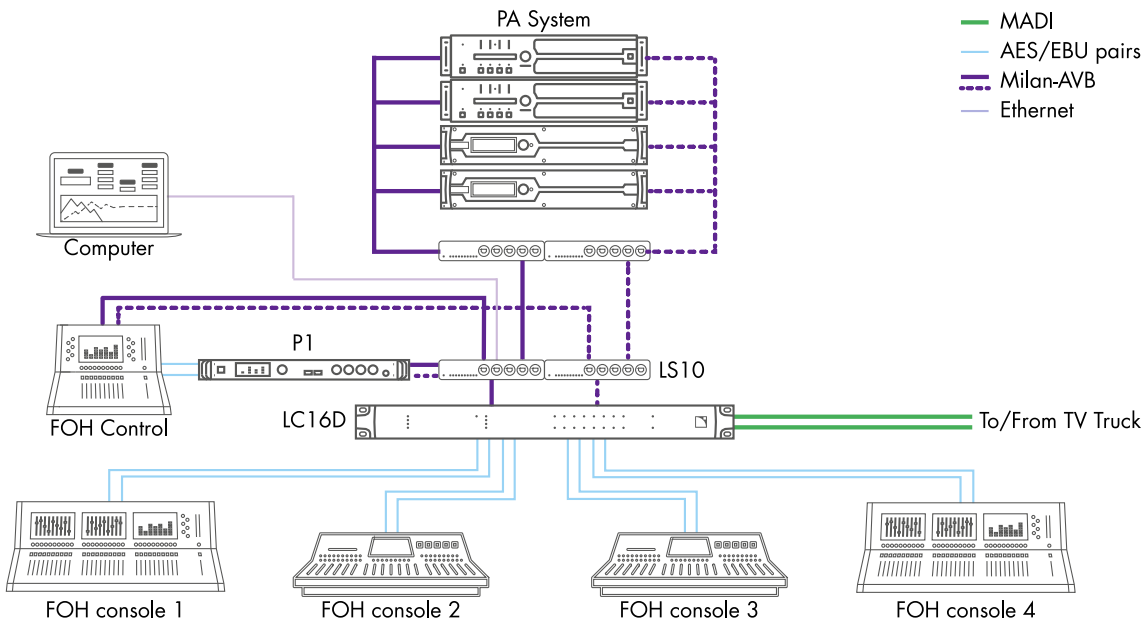

L-ISA Immersive events - LC16D as a Milan-AVB to AES/EBU converter for the fallback system

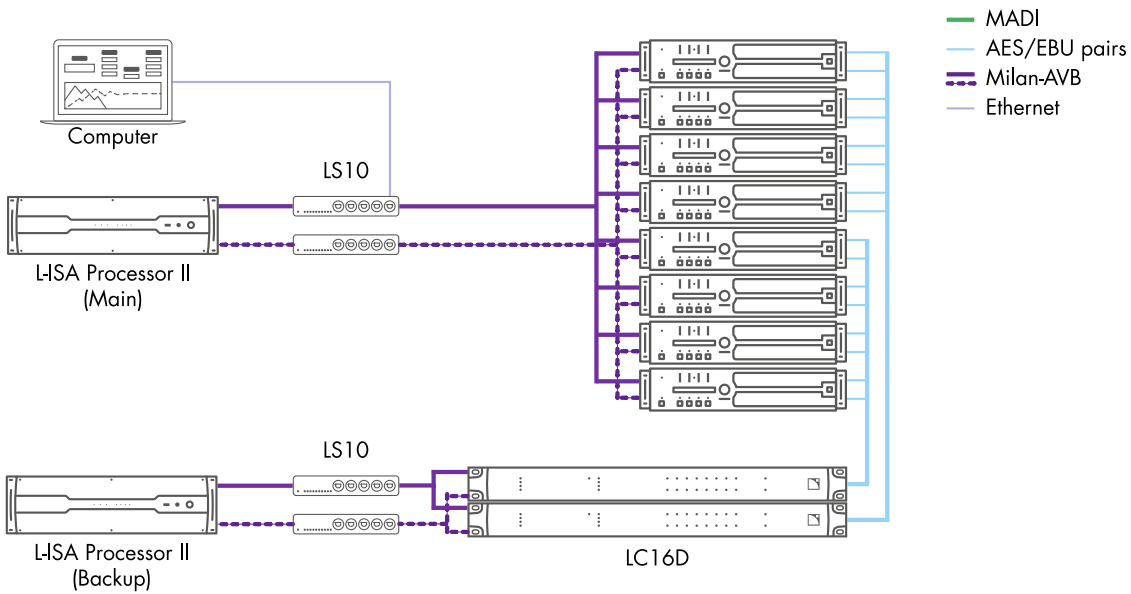

LC16D as an AES67 to AES/EBU and MADI outputs converter

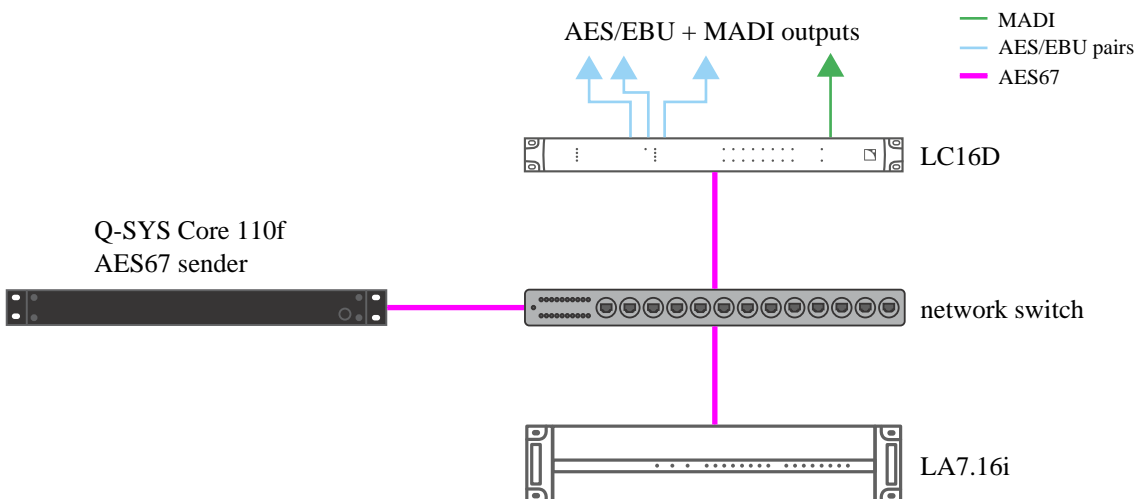

Operation

Powering on/off

LC16D turns on immediately when plugged, and turns off immediately when unplugged (no on/off switch), refer to [Plugging LC16D](#) (p.21).

During booting, all LEDs light up briefly in green or orange.

Interpreting the front panel LEDs

MAINS

The **MAINS** LED displays the status of the mains input.

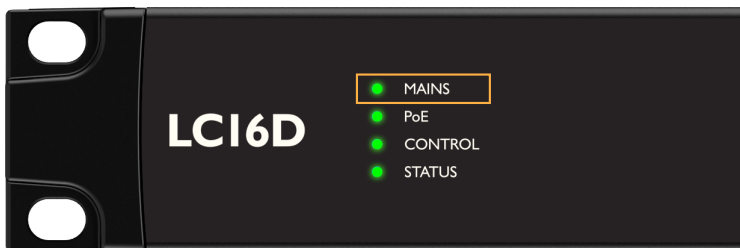

- Green: Mains power is available.
- Off: Mains power is not available.

PoE

The **PoE** LED displays the status of the PoE inputs.

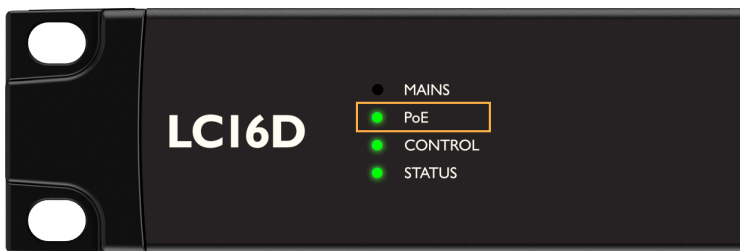

- Green: At least one of the ports is connected to a Power over the Ethernet supply.
- Off: None of the ports are connected to a Power over the Ethernet supply.

Refer to [Power over Ethernet](#) (p.20) for more information.

CONTROL

The **CONTROL** LED on the front panel displays the status of the remote control of LC16D.

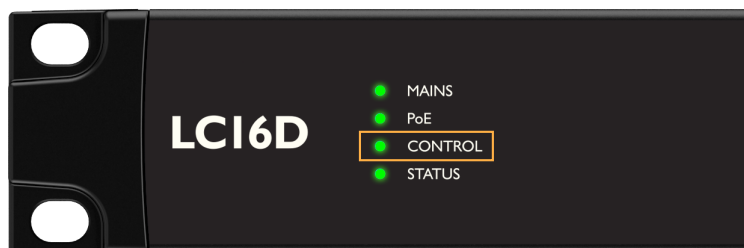

- Green: LC16D is remotely controlled through the LC16D embedded Web interface.
- Orange: LC16D is remotely controlled by a third-party software.
- Off: No software controls LC16D.

STATUS

The **STATUS** LED on the front panel displays the status of LC16D.

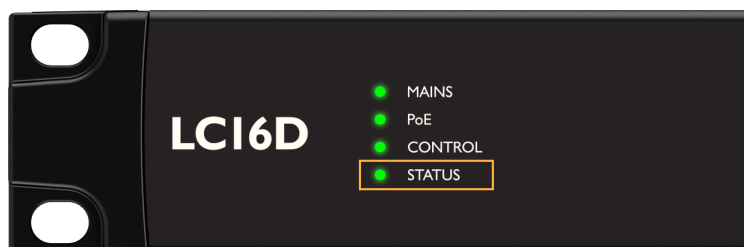

- Green: LC16D operates normally.
- Red (blinking): a fault is detected in LC16D circuitry, and a protection system is active.

CLOCK REFERENCE

The five **CLOCK REFERENCE** LEDs on the front panel display the status of the selected clock reference.



- **INTERNAL:**
 - Green: The internal clock reference is selected.
 - Off: Another clock is selected.
- **WORD CLOCK:**
 - Green (continuous): The word clock is selected and locked.
 - Green (blinking): The word clock is selected and unlocked.
 - Off: Another clock is selected.
- **NETWORK:**
 - Green (continuous):
 - In Milan-AVB mode: One Milan-AVB stream is selected as reference clock and locked.
 - In AES67 mode: The LC16D clock is locked on the PTP clock leader or is the PTP clock leader (elected grandmaster clock by the BMCA). Refer to [PTPv2 \(AES67 mode only\)](#) (p.45).
 - Green (blinking):
 - In Milan-AVB mode: One Milan-AVB stream is selected as reference clock and unlocked.
 - In AES67 mode: The LC16D clock is locking on the PTP clock leader.
 - Off: another clock is selected.
- **MADI:**
 - Green (continuous): The MADI input is selected and locked.
 - Green (blinking): The MADI input is selected and unlocked.
 - Off: another clock is selected.
- **AES/EBU 1:**
 - Green (continuous): The AES/EBU 1 input is selected and locked.
 - Green (blinking): The AES/EBU 1 input is selected and unlocked.
 - Off: Another clock is selected.

AES/EBU IN

The eight **AES/EBU IN** LEDs on the front panel display the status of the 16 AES/EBU inputs (one LED per pair of inputs).

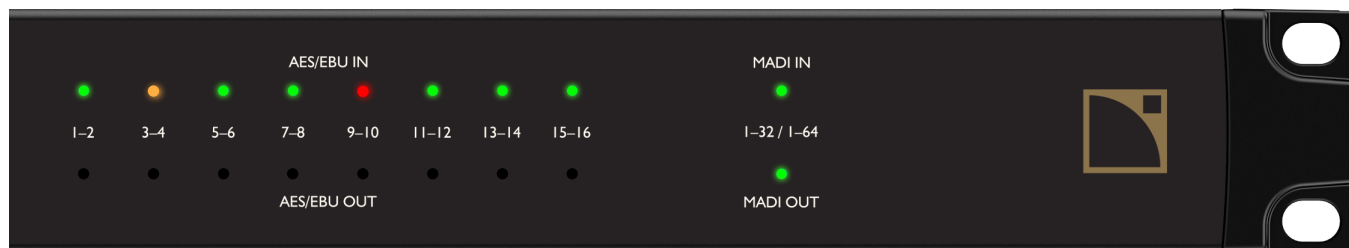

Red	Continuous	The highest level of the channel pair reaches the maximum level (signal clip).
	1 s. blink	There is an error on the channel pair (signal unlocked, etc.).
Orange	Continuous	The highest level of the channel pair reaches 3 dB below the maximum level.
	1 s. blink	Receiving AES/EBU signals but sampling rate is wrong, or AES/EBU source is not synchronized with the selected clock reference.
Green	High	The highest level of the channel pair reaches 20 dB below the maximum level.
	Low	The highest level of the channel pair reaches 60 dB below the maximum level.
Off		Not receiving AES/EBU signals, or the highest level of the channel pair is more than 60 dB below the maximum level.

AES/EBU OUT

The eight **AES/EBU OUT** LEDs on the front panel display the status of the 16 AES/EBU outputs (one LED per pair of outputs).

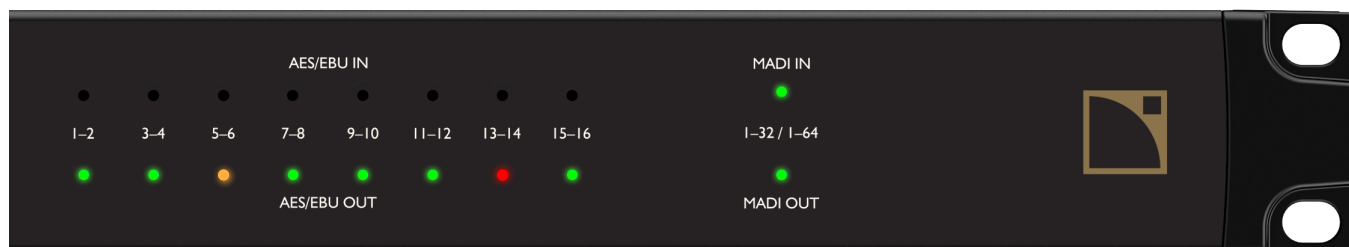

Red		The output level of the channel pair reaches the maximum level (signal clip).
Orange		The highest level of the channel pair reaches 3 dB below the maximum level.
Green	High	The highest level of the channel pair reaches 20 dB below the maximum level.
	Low	The highest level of the channel pair reaches 60 dB below the maximum level.
Off		The highest level of the channel pair is more than 60 dB below the maximum level.

MADI IN

The **MADI IN** LED on the front panel displays the status of the 32 (at 48 kHz) or 64 (at 96 kHz) MADI inputs.

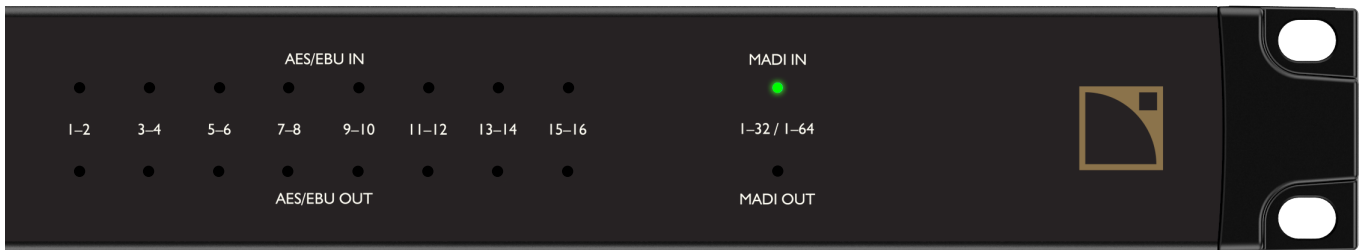

Red	Continuous	The highest level among all MADI inputs reaches the maximum level (signal clip).
	1 s. blink	There is an error on the MADI input (signal unlocked, or the selected system clock frequency does not match the MADI frequency).
Orange	Continuous	The highest level among all MADI inputs reaches 3 dB below the maximum level.
	1 s. blink	Receiving MADI signals but sampling rate is wrong, or MADI source is not synchronized with the selected clock reference.
Green	High	The highest level among all MADI inputs reaches 20 dB below the maximum level.
	Low	The highest level among all MADI inputs reaches 60 dB below the maximum level.
Off		Not receiving MADI signals, or the highest level among all MADI inputs is more than 60 dB below the maximum level.

MADI OUT

The **MADI OUT** LED on the front panel displays the status of the 32 (at 48 kHz) or 64 (at 96 kHz) MADI outputs.



Red		The highest level among all MADI outputs reaches the maximum level (signal clip).
Orange		The highest level among all MADI outputs reaches 3 dB below the maximum level.
Green	High	The highest level among all MADI outputs reaches 20 dB below the maximum level.
	Low	The highest level among all MADI outputs reaches 60 dB below the maximum level.
Off		The highest level among all MADI outputs is more than 60 dB below the maximum level.

LC16D embedded Web interface

Connect LC16D to a control computer using an Ethernet cable.

Open a Web browser and enter the IP address of LC16D to open the LC16D embedded Web interface.

The information displayed depends on the audio network protocol mode of LC16D (Milan-AVB or AES67). The mode can be changed in the [Network](#) (p.43) panel of the **Settings** tab.

Top bar

LC16D embedded Web interface displays a top bar with configuration tools and general status.

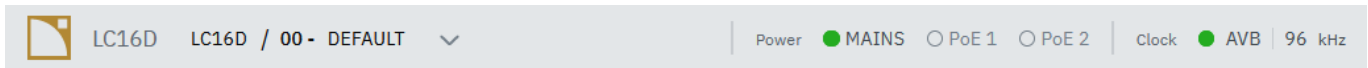

Name

An LC16D can be given a name to identify it. Giving a name can help distinguish different devices in the same system, as the name appears in the tabs of the Web browser used to display the LC16D embedded Web interfaces, as well as in L-Acoustics Device Scanner and Milan Manager, Hive, or other AVDECC Controllers.

To edit, click the field and enter the name.

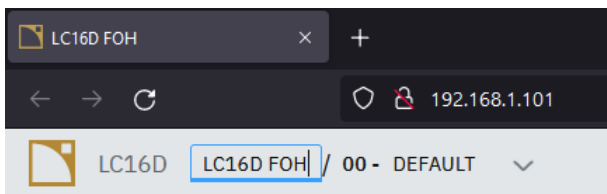

Audio configurations

The parameters stored and loaded as part of an LC16D audio configuration are:

- The selected clock reference.
- The selected ASRC settings.
- The selected AVB or AES67 input and output mappings.

To edit, click the field and enter the configuration name.

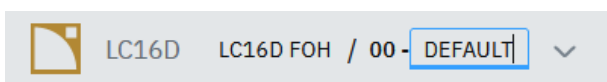

Use the menu to manage the configurations.

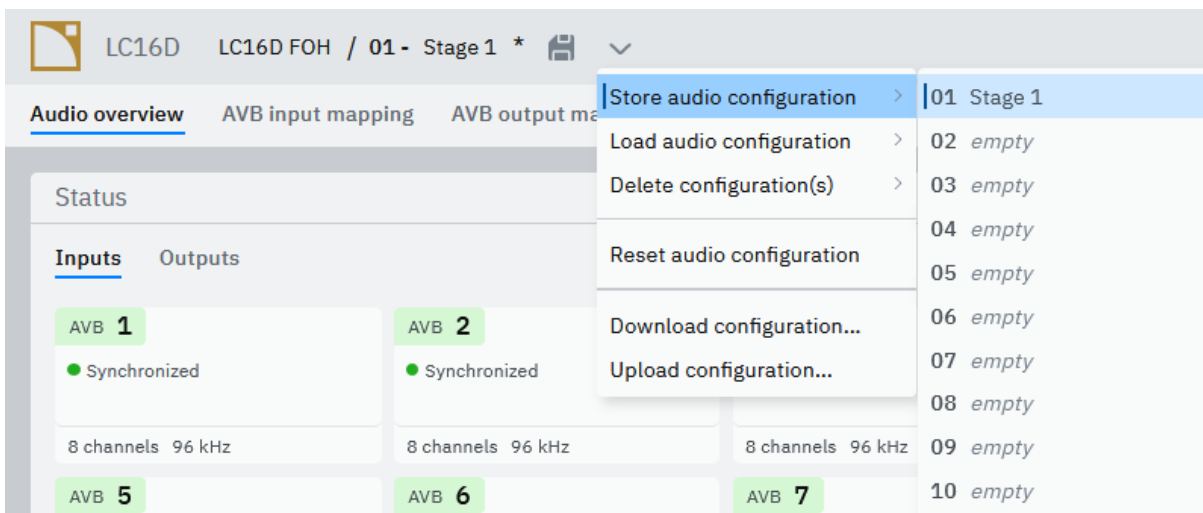

- **Store audio configuration:** Save the current audio configuration into one of the 10 slots available in the LC16D memory.

Once an audio configuration is stored, unsaved changes are notified using a star sign, and a save button is displayed.

- **Load audio configuration:** Load the audio configuration saved into one of the 10 slots available in the LC16D memory.
- **Delete audio configuration:** Delete one or all of the 10 audio configurations saved into the slots of the LC16D memory.
- **Reset audio configuration:** Reset the current audio configuration to the default.
- **Download audio configuration:** Download a *.lcfg file of the current audio configuration.
- **Upload configuration:** Upload a local *.lcfg file to LC16D.

General status

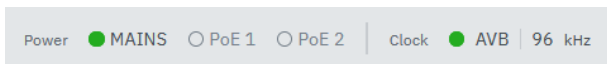

The general status includes:

- The power presence on mains, PoE 1, and PoE 2.
For more information, refer to [MAINS](#) (p.26) and [PoE](#) (p.26).
- The status (green: locked, red: unlocked) and the source of the clock reference.
- The mode at which LC16D is operating: 48 kHz or 96 kHz.

Audio overview

The **Audio overview** tab gives access to panels to monitor the input/output statuses, configure the clock, and configure the AES/EBU ASRC settings.

Status

The **Status** panel gives access to two tabs, **Inputs** and **Outputs**, displaying the statuses on tiles:

- 16 tiles for the 16 Milan-AVB inputs/outputs or the 16 AES67 inputs
- 8 tiles for the 8 AES/EBU inputs/outputs
- 4 to 16 tiles for the 32 to 64 MAD1 inputs/outputs (8 inputs/outputs per tile)

Selecting a tile opens a side panel with an extended view.

Status information in Milan-AVB mode

The screenshot shows the 'Status' panel with two tabs: 'Inputs' and 'Outputs'. The 'Inputs' tab is active, displaying a grid of 16 tiles for AVB 1 through AVB 16. Each tile shows a green dot and the word 'Synchronized', along with '8 ch - 96 kHz'. The AVB 1 tile is highlighted with a blue border. To the right, a side panel for AVB 1 is open, showing a close button (X) and the following information:

- Status:** Synchronized (indicated by a green dot)
- Info:**
 - Number of channels: 8
 - Sampling rate: 96 kHz

Information on the tiles and extended views

	status	number of channels	sampling rate	level meters
Milan-AVB inputs	yes	expected number of channels	expected sampling rate	–
Milan-AVB outputs		yes	yes	
AES/EBU inputs	yes	–	yes	yes
AES/EBU outputs	–		–	
MADI inputs	–	–	–	yes
MADI outputs				

Presentation time (Milan-AVB mode only)

The extended view of the Milan-AVB outputs includes a setting for the presentation time.

The presentation time is set at 2 ms by default, for compliance with the Milan-AVB standard. It is possible to select a lower presentation time, if needed.

On 1 Gb/s AVB networks, delivery after 13 hops is no longer guaranteed when the presentation time is lower than 2 ms. For guaranteed delivery, use **Milan Manager** or **Hive** after stream connection to check that the furthest listeners in the network do not report MSRP latency errors.

A presentation time of 0.5 ms can only be used with a direct Ethernet connection from LC16D to an amplified controller (with no AVB switch in between), for example when used as front-end for monitor applications.

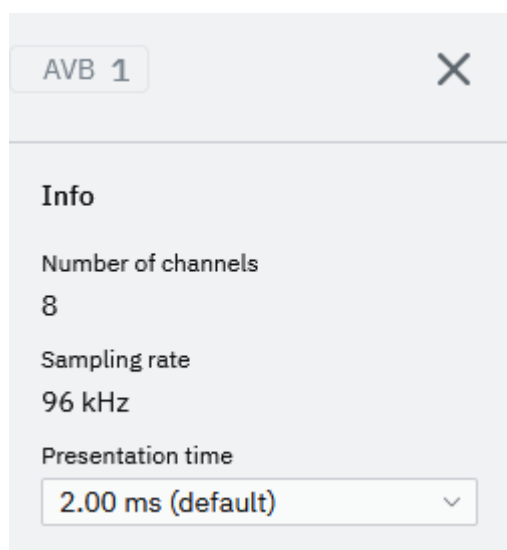

The selection of the presentation time can be unavailable if the stream is already connected or if LC16D is locked by an AVB controller (such as **Milan Manager** or **Hive**).

Status information in AES67 mode

The screenshot displays the 'Status' page for AES67 mode. On the left, there is a grid of 16 input channels, labeled AES67 1 through AES67 16. Each channel is currently set to '8 ch - L24 / 48 kHz'. The 'AES67 1' channel is highlighted with a blue border. On the right, a detailed view for 'AES67 1' is shown, indicating it is 'Not connected'. Below the status, the 'Stream parameters' are listed: Multicast address (239.1.1.0), Remote RTP port (5004), Packet time (1 ms), Stream channels (8), and Format (L24 / 48 kHz).

Stream parameters (AES67 mode only)

Set the stream parameters according to the AES67 sender.



It is highly recommended to use identical latency parameters within a sound system for simplicity.

The 'Stream parameters' panel contains the following fields:

- Multicast address:** 239.1.1.0
- Remote RTP port:** 5004
- Packet time:** 1 ms
- Stream channels:** 8
- Format:** L24 / 48 kHz
- Media clock offset:** 0

- **Multicast address:** enter the multicast address.
- **Remote RTP port:** enter the remote RTP port.
- **Packet time:** select the packet time between 0.333 ms or 1 ms.
- **Stream channels:** select the number of stream channels from 1 to 8.
- **Format:** select the format between L16 or L24.
- **Media clock offset:** enter a media clock offset. The media clock offset should be 0 unless the AES67 sender requires a specific setting.

When LC16D is in redundant network mode, **Multicast address** and **Remote RTP port** for both primary and secondary streams can be set.



When a non-redundant AES67 sender is connected to an LC16D in AES67 mode and redundant network mode, it is recommended to set the secondary multicast address to 0.0.0.0 to turn off the AES67 secondary receiver.

Receiver settings (AES67 mode only)

Set the **Latency** to **Default** and click the **PLAY** button to start receiving.



It is highly recommended to use identical latency parameters within a sound system for simplicity.

If there are packet losses, click the **PAUSE** button, set the **Latency** to **Extra 1 packet time**, and click the **PLAY** button again.

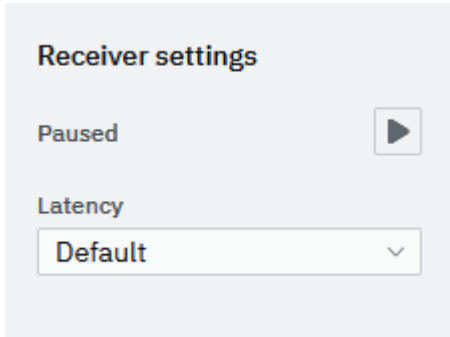

Idle

A tile displaying a disconnected cable means that the corresponding input or output is in idle mode.

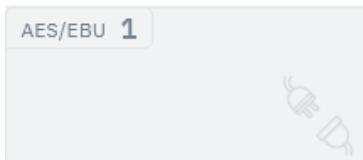

The idle mode means that the input/output is not used.

If an input/output is in use and is disconnected, an error is displayed. If the input/output is disconnected on purpose, it is possible to clear the error in the extended view to reset to the idle mode.

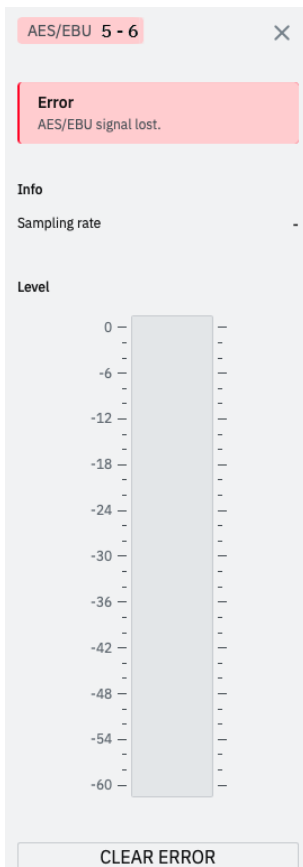

Errors and warnings

When there is an error, the corresponding tile has orange or red highlights.

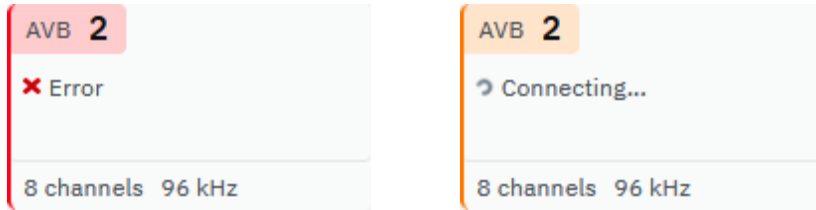

Warnings and errors can include:

- When a single stream is connected to an AVB or AES67 input when LC16D is in redundant mode.
- When the connected stream is no longer received (talker is offline).
- When the connected signal does not match the expected format (sampling rate, number of channels).

Clock

Use the **Clock** panel to set the LC16D clock reference.

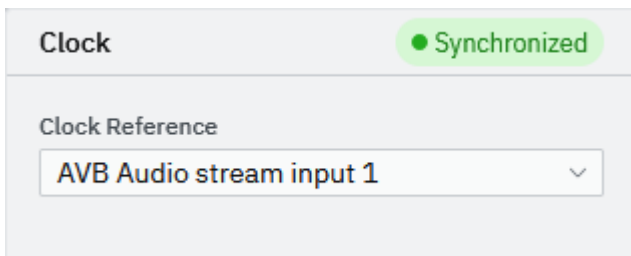

i In AES67 mode, PTP is the only clock reference available. LC16D can be PTP leader (using its internal clock) or PTP follower depending on its PTPv2 priority values (defined in the [Settings](#) (p.43) tab) and the conclusion of the BMCA (Best Master Clock Algorithm).

Select the clock reference:

- Internal
- Word clock
- MADI
- AES/EBU Input 1
- One of the 16 Milan-AVB input streams or the Milan-AVB CRF stream^{*}.

The current clock status is displayed.

Audio input sources are **not** transmitted if their sampling frequency is different from the operating sampling frequency.

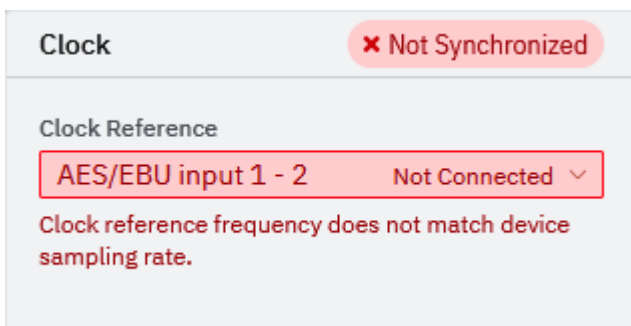

If the selected clock reference is lost, a warning is displayed and LC16D operates in "freewheel" mode. Audio at the same sampling frequency is transmitted but there can be small glitches in the audio as the phase drifts between the clocks. A valid clock reference that matches the audio signals should be selected.

If the sampling frequency matches but the phase is not locked, a warning is displayed. Audio input sources are transmitted but there can be small glitches in the audio.

The selection of the clock reference can be unavailable if LC16D is locked by an AVB controller (such as **Milan Manager** or **Hive**).

* Use an AVDECC Controller (such as **Milan Manager** or **Hive**) to connect the Milan-AVB input streams to LC16D.

ASRC

Use the **ASRC** panel to individually turn on or off the ASRC (Asynchronous Sample Rate Converter) of each AES/EBU input.

ASRC	
AES/EBU Input 1 - 2	<input checked="" type="checkbox"/>
AES/EBU Input 3 - 4	<input checked="" type="checkbox"/>
AES/EBU Input 5 - 6	<input checked="" type="checkbox"/>
AES/EBU Input 7 - 8	<input checked="" type="checkbox"/>
AES/EBU Input 9 - 10	<input type="checkbox"/>
AES/EBU Input 11 - 12	<input type="checkbox"/>
AES/EBU Input 13 - 14	<input type="checkbox"/>
AES/EBU Input 15 - 16	<input type="checkbox"/>

Turning off the ASRC can be used to propagate a particular clock domain from an AES/EBU input, or if all AES/EBU inputs are on the same clock.

AVB or AES67 input mapping

Use the **AVB input mapping** tab to configure the mapping of the 16 Milan-AVB or AES67 input streams (on the left) to the 16 AES/EBU outputs and to the 32 or 64 MADI outputs (on the top).

Use an AVDECC Controller (such as **Milan Manager** or **Hive**) to connect the Milan-AVB input streams to LC16D.

In \ Out		AES/EBU outputs							
		1		2		3		4	
		1	2	3	4	5	6	7	8
AVB audio input streams	1	█							
	2		█						
	3			█					
	4				█				
	5					█			
	6						█		
	7							█	
	8								█

Use the arrows to collapse or expand parts of the matrix table.

Click a cell in the matrix to map a Milan-AVB or AES67 input stream to an output. The cell turns blue. Click the cell again to remove the mapping. Click and hold over multiple cells in a line or a diagonal to map multiple cells at once. The same Milan-AVB or AES67 input streams can be used several times in the mapping. The blue lines at the top of columns or the side of rows indicate the presence of an active mapping in that column/row.

There is a signal status at the top of each column:

- Green: The level reaches 60 dB below the maximum level.
- Off: Not receiving signals, or the level is more than 60 dB below the maximum level.

Use the **Inputs** and **Outputs** filters at the top to select which input streams and outputs are displayed in the matrix table. Click **Clear** to clear all filters.

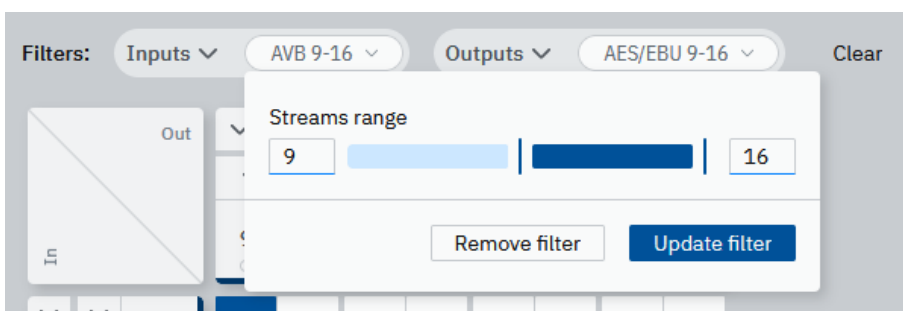

Default input mapping

	AES/EBU outputs		MADI outputs							
	1-8	9-16	1-8	9-16	17-24	25-32	33-40	41-48	49-56	57-64
Milan-AVB or AES67 input stream 1, ch 1-8	x									
Milan-AVB or AES67 input stream 2, ch 1-8		x								
Milan-AVB or AES67 input stream 3, ch 1-8			x							
Milan-AVB or AES67 input stream 4, ch 1-8				x						
Milan-AVB or AES67 input stream 5, ch 1-8					x					
Milan-AVB or AES67 input stream 6, ch 1-8						x				
When operating at 48 KHz sampling frequency:										
Milan-AVB or AES67 input stream 7, ch 1-8							x			
Milan-AVB or AES67 input stream 8, ch 1-8								x		
Milan-AVB or AES67 input stream 9, ch 1-8									x	
Milan-AVB or AES67 input stream 10, ch 1-8										x
Milan-AVB or AES67 input streams 11-16	no channel mapped by default									

The input mapping can be unavailable if LC16D is locked by an AVB controller (such as **Milan Manager** or **Hive**).

AVB output mapping

Use the **AVB output mapping** tab to configure the mapping of the 16 AES/EBU inputs and the 32 or 64 MADI inputs (on the top) to the 16 Milan-AVB output streams (on the right).

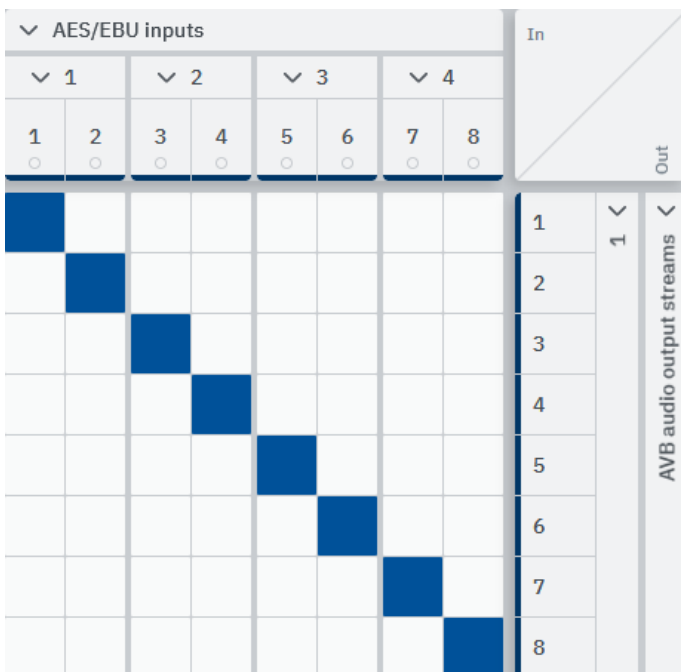

Use the arrows to collapse or expand parts of the matrix table.

Click a cell in the matrix to map an input to a Milan-AVB output stream. The cell turns blue. Click the cell again to remove the mapping. Click and hold over multiple cells in a line or a diagonal to map multiple cells at once. The blue lines at the top of columns or the side of rows indicate the presence of an active mapping in that column/row.

There is a signal status at the top of each column:

- Green: The level reaches 60 dB below the maximum level.

- Off: Not receiving signals, or the level is more than 60 dB below the maximum level.

Use the **Inputs** and **Outputs** filters at the top to select which inputs and output streams are displayed in the matrix table. Click **Clear** to clear all filters.

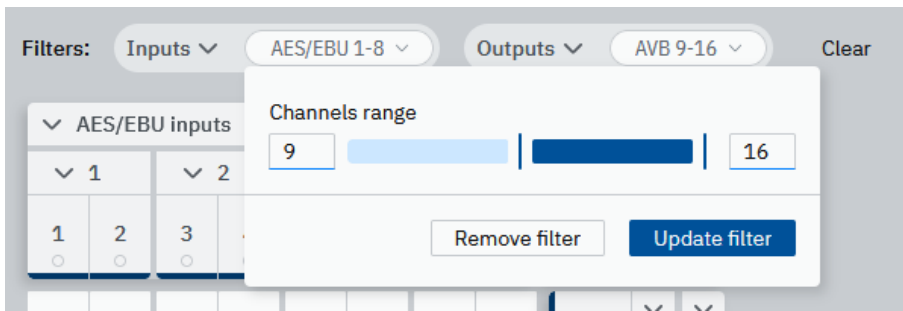

Default output mapping

AES/EBU inputs		MADI inputs								
1-8	9-16	1-8	9-16	17-24	25-32	33-40	41-48	49-56	57-64	
x										Milan-AVB output stream 1, channels 1-8
	x									Milan-AVB output stream 2, channels 1-8
		x								Milan-AVB output stream 3, channels 1-8
			x							Milan-AVB output stream 4, channels 1-8
				x						Milan-AVB output stream 5, channels 1-8
					x					Milan-AVB output stream 6, channels 1-8
When operating at 48 KHz sampling frequency:										
						x				Milan-AVB output stream 7, channels 1-8
							x			Milan-AVB output stream 8, channels 1-8
								x		Milan-AVB output stream 9, channels 1-8
									x	Milan-AVB output stream 10, channels 1-8
no channel mapped by default										Milan-AVB output streams 11-16

The output mapping can be unavailable if LC16D is locked by an AVB controller (such as **Milan Manager** or **Hive**).

GPIO

Use the **GPIO** tab to configure the LC16D GPIO. Refer to [General Purpose I/O \(GPIO\)](#) (p.19) for more information on the GPIO connector.

The screenshot displays the configuration interface for four GPIO pins. Each pin has a status indicator (Low, Closed, Closed, Open) and an 'Operating Mode' section with 'INPUT' and 'OUTPUT' buttons. GPIO 1 is in 'INPUT' mode with two actions: 'High to low' (Load configuration A, number 1) and 'Low to high' (Load configuration B, number 2). GPIO 2 is in 'OUTPUT' mode with function 'Ethernet link up' and 'Select Ethernet ports' set to 'Port 1'. GPIO 3 is in 'OUTPUT' mode with function 'State' and 'Switch state' set to 'Close'. GPIO 4 is in 'OUTPUT' mode with function 'Alive' and 'Period (seconds)' set to '60 s'.

LC16D GPIO connector has four pins available either as input or output.

Inputs

Every GPI can have two actions:

- one action when its state changes from LOW to HIGH,
- one action when its state changes from HIGH to LOW.

This allows the GPI to adapt to the type of device used for triggering the actions (push button, two-state switch, dry contact relay, etc.).

List of actions

List of GPI actions available with firmware 2.13.1. This list may evolve in future firmware releases.

Action name	Description	Options
Choose an action	The GPI is not used	N/A
Load configuration A	Load the configuration in selected memory slot A.	Configuration slot A (1 to 10)
Load configuration B	Load the configuration in selected memory slot B.	Configuration slot B (1 to 10)
Load next configuration	Load the next available configuration.	N/A
Load previous configuration	Load the previous available configuration.	N/A

Load configuration A/B

If a configuration slot is empty when trying to load it, the command is discarded.

Each GPI has its own A and B options for configuration slot selection allowing to load up to 10 different configuration slots from the four GPI of LC16D.

Load Next/Previous configuration

The next/previous configuration ignores empty configuration slots, and is circular (the next configuration slot after 10 is 1, and conversely). If all configuration slots are empty, the command is discarded.

Outputs

By default, all GPO are in the OPEN state.

List of functions

List of GPO functions available with firmware 2.13.1. This list may evolve in future firmware releases.

Function name	Description	Options
Choose a function	The GPO is not used.	N/A
State	Manually set the GPO state.	Switch state
Alive	Periodically switch between OPEN and CLOSED states.	Choose a time lapse period (1 to 60 seconds)
Fault	Report a selection of possible faults.	<ul style="list-style-type: none"> • Stream 1 to 16 • AES/EBU 1 to 8 • Ethernet Port 1 and 2
Ethernet link up	Report a failing or disconnected Ethernet network port.	Ethernet Port 1 and 2
AES/EBU locked	Report an AES/EBU lock issue on any of the 8 AES/EBU inputs.	AES/EBU 1 to 8
AVB locked	Report an AVB lock issue on the AVB input streams.	Stream 1 to 16

Alive

The GPO state is alternating between OPEN and CLOSED states every time the time lapse period (set from 1 to 60 seconds) is elapsed.

Fault / Ethernet link up / AES/EBU locked / AVB locked

Multiple selection is possible among the available fault options. If any of the selected options is reporting a fault, then the GPO reports a fault. A fault is reported by the GPO state OPEN. In case of no fault detected, the GPO state is CLOSED.

GPO state	Condition
OPEN	At least one of the selected options is reporting a fault: <ul style="list-style-type: none"> • At least one of the selected AVB input streams is not locked (primary OR secondary), or there is no AVB input stream selected for this function. • At least one of the selected AES/EBU inputs is not locked, or there are no AES/EBU inputs selected for this function. • At least one of the selected Ethernet ports is DOWN, or there are no Ethernet ports selected for this function.
CLOSED	All the selected options are not reporting any fault: <ul style="list-style-type: none"> • All selected AVB input streams are locked (primary AND secondary). • All selected AES/EBU inputs are locked. • All selected Ethernet ports are UP.

Settings

The **Settings** tab gives access to panels to configure LC16D network, sampling rate, and LED brightness, and to update LC16D firmware.

Network

Use the **Network** panel to edit the network configuration of LC16D.

The image shows two side-by-side screenshots of the Network configuration panel. The left screenshot shows the 'EDIT' button next to the IP settings, while the right screenshot shows the 'APPLY' button. The IP settings are: IP address 192.168.1.100, Subnet mask 255.255.255.0, and Gateway 0.0.0.0.

Audio protocol

Select the **Audio protocol** mode between Milan-AVB and AES67. Changing the **Audio protocol** mode reboots LC16D.

IP Settings

Click **EDIT** to configure the **IP settings** (IP address, netmask, and gateway).



After applying a change to the IP address, the Web browser is redirected to the new IP address.

An IP address is a unique identifier for a network device on a given IP network. In IPv4 networking, it is made of 4 bytes (32 bits). An IP address is composed of a subnet address and a host address. The host address serves as a unique device identifier on the subnet. The subnet mask determines how many bits define the subnet address, and how many define the host address.

By convention, the first possible number of the host address is reserved to designate the subnet, and the last number is reserved to communicate with all devices of the subnet (IP broadcast address).

The factory default IP settings of all L-Acoustics devices are:

- IP address: 192.168.1.100
- Subnet address: 192.168.1.0/24
- IP broadcast address: 192.168.1.255
- Subnet mask: 255.255.255.0

With these settings, the first three bytes of the IP address (192.168.1) define the subnet address, and the last byte is the host address (100).

In general, it is recommended to:

- Use the default subnet address and subnet mask.
- Edit the device host address to provide a unique identifier to each unit: use consecutive IP addresses starting from 192.168.1.1 up to 192.168.1.253.
- Set the control computer to 192.168.1.254.

However, it is possible to configure other IP settings when required by network administration. Subnet mask may be defined from 255.0.0.0 to 255.255.255.0, and the IP and gateway addresses must both belong to one of the following IP ranges (standards for Private Local Area Networks):

- 10.0.0.1 to 10.255.255.254
- 100.64.0.1 to 100.127.255.254
- 172.16.0.1 to 172.31.255.254
- 169.254.0.1 to 169.254.255.254 (not recommended)
- 192.168.0.1 to 192.168.255.254

 **LC16D must be using the same subnet and subnet mask as the control computer and the other units in the network.**

A gateway IP address is an advanced setting reserved for specific applications such as amusement parks, campuses, and multi-room venues with a centralized third-party supervision tool (Crestron, Q-SYS, etc.). In such contexts, the supervision tool is often located in a different subnet that is interconnected with the subnets of the units. Interconnection is achieved using a gateway. The gateway address must be set on the units to enable communication with the supervision tool.

Network mode

 **Risk of broadcast storm.**
 To enable the redundancy mode: connect the primary network cables in a star topology, and first change the mode, then connect the secondary network cables.
 To disable the redundancy mode: always disconnect the secondary network cables first, then change the mode.

Changing network mode requires rebooting LC16D.

Select the network mode as **NORMAL** or **REDUNDANT**.

In normal mode:

- LC16D has a single IP address.
- Either Ethernet port can be used to connect to the network.

In redundancy mode:

- LC16D has two IP addresses, one for the primary network, one for the secondary network.
- Ethernet port 1 is dedicated to the primary network, Ethernet 2 is dedicated to the secondary network.

Using the redundancy mode reduces the risk of network failure: in case of failure of the primary network, the signal of the secondary network is automatically and seamlessly picked up and used as a replacement. When the primary network is up and running again, it is automatically used again, seamlessly, with no user intervention.

After setting LC16D in redundant mode, set up the two IP addresses.

In AVB or AES67 redundant mode, the host address is always made identical for both the Primary and the Secondary network. The subnet address of the Secondary network is that of the Primary +1. For example, with default settings:

- Primary port: 192.168.1.100
- Secondary port: 192.168.2.100

The subnet mask setting always applies to both networks. When using smaller subnet masks, the host address is also made identical. For example:

- Primary port: 172.16.1.100
- Secondary port: 172.17.1.100

The Gateway address is only available for the Primary network.

RSTP

Enable/Disable the RSTP (Rapid Spanning Tree Protocol).

When RSTP is enabled, the protocol detects and automatically disables Ethernet ports to cut loops created by redundant links in the network, and avoid damaging broadcast storms. In case of a cable or switch failure in the network, the protocol can re-enable these ports to restore connectivity.

Enable RSTP if the LC16D is part of a network loop. Disable RSTP if there is no risk of LC16D being part of a network loop.

PTPv2 (AES67 mode only)

Adjust the values of **Priority 1** and **Priority 2** to define the priority ranking of LC16D in the election of the PTPv2 grandmaster clock. A lower value corresponds to a higher priority.

! In most cases, it is recommended to define high values for **Priority 1** and **Priority 2** to make sure LC16D is **NOT** elected as grandmaster clock.

A **Me** label is displayed when the device is elected as grandmaster clock.

PTPv2

Priority 1: 254 Priority 2: 254

Grandmaster

PTPv2

Primary

Priority 1: 100 Priority 2: 254

Grandmaster

Me

Sampling rate

Use the **Sampling rate** panel to configure the LC16D sampling rate.

Sampling rate

Frequency: 96 kHz

i Sampling rate cannot be changed when AVB streams are connected.

i In AES67 mode, LC16D can only operate at the 48 kHz sampling rate.

Select the mode at which LC16D is operating: 48 kHz or 96 kHz.

This setting impacts the frequency of the Milan-AVB streams. For this reason, it is not possible to change the clock reference when Milan-AVB streams are already connected.

The selection of the sampling rate can be unavailable if LC16D is locked by an AVB controller (such as **Milan Manager** or **Hive**).

LED brightness

The brightness of the LED can be modified to adapt to a very bright or very dark environment.

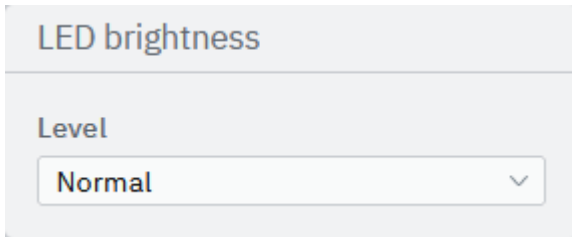

LED brightness

Level

Normal

Device info

Use the **Device info** panel to check the version number and the date of the firmware currently installed on LC16D, update the firmware, and check the MAC address and the serial number of LC16D.

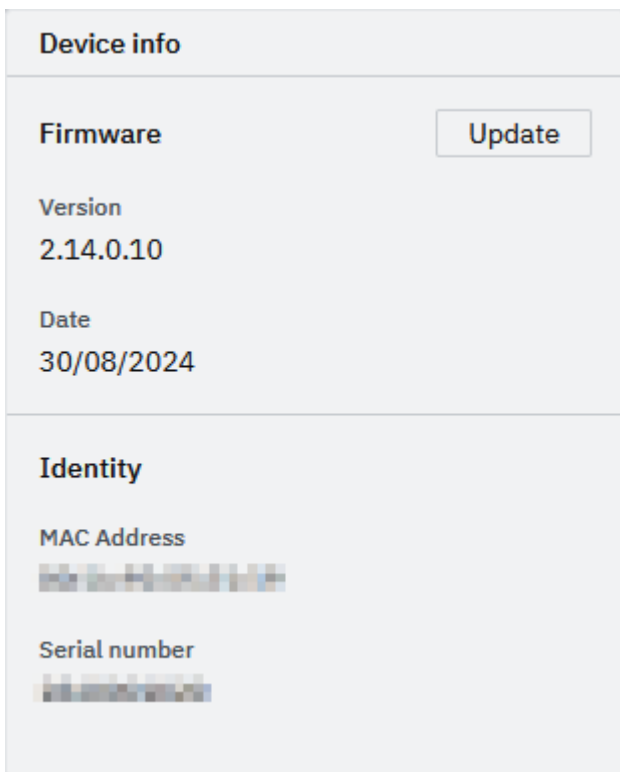

Device info

Firmware Update

Version
2.14.0.10

Date
30/08/2024

Identity

MAC Address
[blurred]

Serial number
[blurred]

Click **Update** to browse to the firmware file location on the control computer. The firmware update process reboots LC16D.

! After a firmware update, clear the Web browser cache to make sure the LC16D embedded Web interface is properly refreshed.

Additional actions

Click the three dots on the right to open a menu for additional actions.

Reboot

Reboot LC16D.

Reset to factory defaults

Reset LC16D to factory default settings.

Specifications

Specifications

All values given in this section are typical values.

General

Power supply

Mains rating	100 V AC - 240 V AC ($\pm 10\%$), 50 Hz - 60 Hz
Power consumption	Maximum: 12 W Typical/Idle: 8 W
Mains inputs	1 IEC C13 V-Lock compatible socket
PoE (Power over Ethernet)	Class 3 PoE Powered Device (PD) compatible with any IEEE 802.3at-2009 third-party Power Sourcing Equipment (PSE) using the 2 Ethernet etherCON I/Os
Power redundancy	Seamless redundancy between AC mains inputs (highest priority), PoE1 (second highest priority), and PoE2

Protection

Cooling system	temperature controlled fan low noise
----------------	---

Signal processing

Milan-AVB

Featured AVB entities	MILAN™-compatible Milan-AVB Talker and Milan-AVB Listener
Standards	Ethernet Milan-AVB IEEE 802.1BA-2011: Transport: IEEE 1722-2016 (AVTP) Control: IEEE 1722.1-2021 (ATDECC) Timing and synchronization: IEEE 802.1AS-2011
Redundancy	RSTP (Rapid Spanning Tree Protocol) MILAN seamless redundancy
Input audio streams	Number: 16 in normal mode and in redundancy mode Class: A Maximum network latency: 2 ms Formats: AAF PCM32, up to 8 channels at 48 kHz when the device is operating at 48 kHz at 96 kHz when the device is operating at 96 kHz
Input clock stream	1 CRF at 48 kHz

Output audio streams Number: 16 in normal mode and in redundancy mode
 Class: A
 Maximum network latency (Talker presentation time offset): fixed at 2 ms
 Formats: AAF PCM32, up to 8 channels
 at 48 kHz when the device is operating at 48 kHz
 at 96 kHz when the device is operating at 96 kHz

Output clock streams 1 CRF at 48 kHz

Media clock upon user selection:
 internal clock
 word clock
 Milan-AVB input stream
 MADI input
 AES1 input

AES67

Standards AES67: AES67-2023
 Transport: RTP over UDP/IP
 Network and media clocking: IEEE 1588-2008, PTPv2

Input audio stream Number: 16 (in normal or redundancy mode)
 Formats:
 L16, up to 8 channels, at 48 kHz
 L24, up to 8 channels, at 48 kHz
 Packet times supported: 0.333 ms or 1 ms
 Default latency: 3 packet times
 Maximum latency: 4 packet times

Media clock Derived from the network grandmaster clock elected according to PTPv2

Control LC16D embedded Web interface, L-Acoustics Q-SYS plug-in

AES/EBU

Inputs

Number of channels 16, with integrated ASRC
 Sampling rate 44.1 kHz to 192 kHz
 Latency compensation No
 Bypass/Link No
 AES Input Sync AES/EBU 1 clock at 48 kHz / 96 kHz (ASRC can be disabled individually)

Outputs

Number of channels 16
 Sampling rate 48 kHz and 96 kHz
 Latency compensation No

MADI (AES10-2003)**Inputs**

Number of channels 64 at 48 kHz
32 at 96 kHz

Sample Rate Conversion No

Outputs

Number of channels 64 at 48 kHz
32 at 96 kHz

Sample Rate Conversion No



The 96 kHz legacy SMUX pattern is not supported.

Word clock

Input frequency 48 kHz / 96 kHz
Input termination 75 Ω
Input level from 1 Vpp to 5 Vpp input level, overvoltage protected
Output frequency 48 kHz / 96 kHz
Output termination 75 Ω
Output level 5 Vpp into open load

Internal conversion latency*

from	to	latency
AES/EBU (ASRC disabled) or MADI	Milan-AVB or AES67	0.2 ms
AES/EBU 96 kHz (ASRC enabled)	Milan-AVB 96 kHz	0.3 ms (minimum)
AES/EBU 96 kHz (ASRC enabled)	Milan-AVB or AES67 48 kHz	0.4 ms (maximum)
Milan-AVB or AES67	AES/EBU or MADI	negligible (one sample)

* For global chain latency, add the presentation time of the AVB stream.

Remote control

Network 2 × 1 Gb/s Ethernet etherCON I/Os
General Purpose I/O (GPIO) 1 × 10-point terminal block:
4 configurable inputs (optocouplers) / outputs (relay), fully isolated
1 ground pin, 3 chassis ground pins
Service port 1 Micro USB
L-Acoustics remote control software LC16D embedded Web interface, available through a network connection
L-Acoustics Device Scanner, used with a network connection
USB Terminal, used with a USB connection

Interface

Status indicators	1 single color LED for power
	1 single color LED for PoE (Power over Ethernet)
	1 dual color LED for L-NET
	1 dual color LED for status
Clock reference indicators	1 single color LED for internal clock
	1 single color LED for word clock
	1 single color LED for Milan-AVB clock
	1 single color LED for MADI clock
	1 single color LED for AES/EBU 1 clock
Input indicators	8 dual color LEDs for AES/EBU inputs (one per pair)
	1 dual color LED for MADI inputs
Output indicators	8 dual color LEDs for AES/EBU outputs (one per pair)
	1 dual color LED for MADI outputs

Input/output connectors

AES/EBU outputs	1 DB25 female connector, AES59 8-way pinout annex C, UNC 4-40 screw locks
AES/EBU inputs	1 DB25 female connector, AES59 8-way pinout annex C, UNC 4-40 screw locks
MADI outputs	1 BNC connector, 75 Ω terminated
MADI inputs	1 BNC connector, 75 Ω terminated
Word clock output	1 BNC connector, 75 Ω terminated
Word clock input	1 BNC connector, 75 Ω terminated
Milan-AVB I/O, network I/O, and PoE (Power over Ethernet) inputs	2 \times 1 Gb/s Ethernet etherCON I/Os

Storage and operating conditions

Storage temperature	-20 $^{\circ}$ C / -4 $^{\circ}$ F to 70 $^{\circ}$ C / 158 $^{\circ}$ F
Operating temperature	-5 $^{\circ}$ C / 23 $^{\circ}$ F to 50 $^{\circ}$ C / 122 $^{\circ}$ F
Maximum altitude	2000 m
Climate	moderate, tropical

Physical data

Height	1U
Weight	2 kg/4.41 lb
Finish	black
Protection rating	IP3x

LC16D dimensions

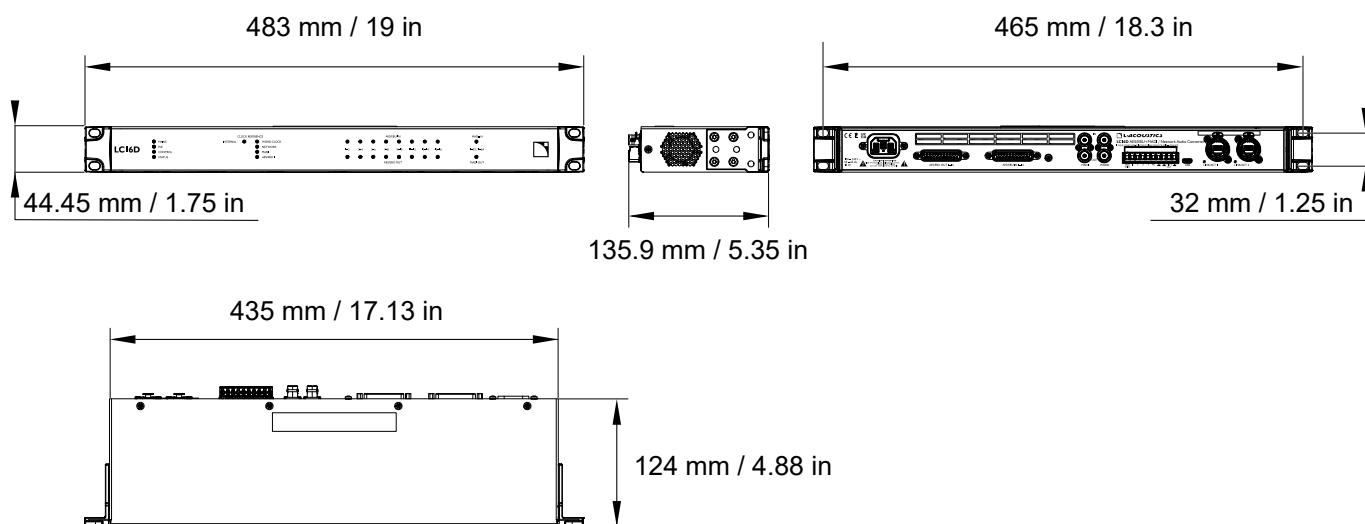

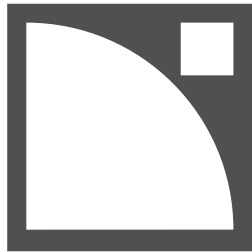

L-ACOUSTICS

L-Acoustics

13 rue Levacher Cintrat - 91460 Marcoussis - France

+33 1 69 63 69 63 - info@l-acoustics.com

www.l-acoustics.com

☐ **L-ACOUSTICS**
GROUP